

# Operating Manual

## FTC320 Ex

Gas analysis using thermal conductivity measurement for zone 2 ATEX II 3G Ex nR IIC T4 Gc



# About this manual

Thank you for using the Messkonzept FTC320. It has been designed and manufactured using the highest quality standards to give you trouble-free and accurate measurements.

## Copyright © 2024 Messkonzept GmbH .

This document is protected by copyright. Neither the whole nor any part of it or the information contained in it may be adapted or reproduced in any form except with the prior written approval of Messkonzept.

All information of technical nature and particulars of the product and its use (including the information in this manual) are given by Messkonzept in good faith. However, it is acknowledged that there may be errors or omissions in this manual. Images and drawings may not be in scale. For the latest revisions to this manual contact Messkonzept or visit [www.messkonzept.de](http://www.messkonzept.de).

Messkonzept welcomes comments and suggestions relating to the product and this manual.

**Please Note!** The design of this instrument is subject to continuous development and improvement. Consequently, this instrument may incorporate minor changes in detail from information contained in this manual.

**Important!** In correspondence concerning this instrument, please specify the model and serial number as given on the label on the right side of the instrument.

All correspondence should be addressed to:

Messkonzept GmbH  
Niedwiesenstr. 33  
60431 Frankfurt  
Germany

Tel: +49(0)69 53056444  
Fax: +49(0) 69 53056445  
email: [info@messkonzept.de](mailto:info@messkonzept.de)  
[www.messkonzept.de](http://www.messkonzept.de)

This manual applies to: FTC320 using firmware version 2.000 or newer  
Date of Release: March 29, 2024

# Quick Installation Guide

For quick installation of the FTC320 we recommend reading the following chapters of this manual:

- Chapter 1 "Operator Safety": Important warnings, safety instructions and intended use.
- Chapter 3 "Installation of the Instrument": Mounting, pneumatic and electric connection. Also see Chapter 10 "Appendix: Dimensional Drawing"
- Section 2.2 "Calibration": Recommended calibration intervals, the calibration process and recommended test of functionality after bringing into service.

# Contents

<b>1</b>	<b>Operator Safety</b>	<b>5</b>
1.1	Notes on Safety Conventions and Icons . . . . .	5
1.2	Safety instructions for use in explosion hazard areas Zone 2 . . . . .	6
1.3	Intended Use . . . . .	6
1.3.1	Disposal instructions . . . . .	8
<b>2</b>	<b>Principle of Measurement</b>	<b>9</b>
2.1	Determining Concentrations via Thermal Conductivity . . . . .	9
2.1.1	FTC320 Detector Unit . . . . .	12
2.2	Calibration . . . . .	13
2.2.1	Offset and Gain Calibration . . . . .	13
2.2.2	Performing Calibration . . . . .	17
2.2.3	Use of Substitute Gases . . . . .	17
<b>3</b>	<b>Installation of the Instrument</b>	<b>18</b>
3.1	Mounting of the FTC320 . . . . .	18
3.2	Gas Ports . . . . .	19
3.3	Leakage Test . . . . .	19
3.3.1	Housing Seal . . . . .	19
3.4	Electrical Connectors and Ground . . . . .	19
3.4.1	Requirements for Electrical Connections . . . . .	20
3.4.2	Ground . . . . .	21
3.4.3	Data exchange via serial interface (RS-232) . . . . .	22
<b>4</b>	<b>The Front Panel</b>	<b>23</b>
4.1	Display . . . . .	23
4.2	Keys . . . . .	23
<b>5</b>	<b>Instrument display</b>	<b>25</b>
5.1	Warm-up Screen . . . . .	25
5.2	Operation Screen . . . . .	25
5.2.1	Display of one measured value . . . . .	26
5.2.2	Display of several measured values . . . . .	26
<b>6</b>	<b>General instrument settings</b>	<b>27</b>
6.1	Top Level Main Menu . . . . .	27
6.2	Diagnosis . . . . .	27
6.2.1	Parameter Menu . . . . .	28

6.2.2	Errors and Maintenance Requests . . . . .	28
6.2.3	Test of Relays, Analog Outputs and Connections . . . . .	30
6.3	Instrument Setup . . . . .	31
6.3.1	Display Unit . . . . .	31
6.3.2	Response Time Setup . . . . .	31
6.3.3	Access Modes . . . . .	32
6.4	Output Setup . . . . .	33
6.4.1	Current Output Setup . . . . .	33
6.4.2	Voltage Output Setup . . . . .	37
6.4.3	Relay Setup . . . . .	39
6.5	Expert Setup . . . . .	42
6.5.1	Parameter . . . . .	43
6.5.2	Passwords . . . . .	43
6.5.3	Reset Functions . . . . .	44
<b>7</b>	<b>Measurand related settings</b>	<b>45</b>
7.1	Gas pair selection (only with Multi Gas Mode) . . . . .	45
7.2	Calibration . . . . .	47
7.2.1	Set Offset Gas Concentration . . . . .	47
7.2.2	Set Gain Gas Concentration . . . . .	47
7.2.3	Offset Calibration . . . . .	48
7.2.4	Gain Calibration . . . . .	49
7.3	Limit Setup . . . . .	49
7.3.1	Configuration of a Limit . . . . .	50
7.3.2	Examples . . . . .	52
7.4	Mapping of Analog Output . . . . .	53
<b>8</b>	<b>Appendix: System Errors</b>	<b>54</b>
<b>9</b>	<b>Appendix: Specifications</b>	<b>57</b>
9.1	Specification of Thermal Conductivity Measurement . . . . .	57
9.1.1	Gas Flow . . . . .	58
9.2	Electrical Specifications . . . . .	59
9.3	Permissible Conditions of the sample to be measured . . . . .	60
9.4	Environmental conditions . . . . .	60
9.5	Dimensions . . . . .	61
<b>10</b>	<b>Appendix: Dimensional Drawing</b>	<b>62</b>

## Chapter 1

# Operator Safety

This section provides information and warnings which must be followed to ensure safe operation and retain the instrument in safe condition. Read this section carefully before installing the device and using the software.

### 1.1 Notes on Safety Conventions and Icons



The exclamation mark symbol draws attention to application errors or actions that can lead to safety risks, including injury to persons or malfunctions - possibly destruction of the device.

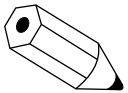

This icon indicates an additional function or hint.



### Startup Safety Notes

- For the safe operation of the device, please pay attention to all instructions and warnings in this manual.
- Start operating the device only after it has been installed properly. A competent and authorized person is required for installation, connection, and operation of the device. Please read and follow this manual for the installation.
- Defective devices must be disconnected from the process! This applies for apparent damage to the device, such as physical damage, but also in the case of unclarified malfunctions in the operation. Separate the device from the process pneumatically (both gas inlet and gas outlet) and remove the power supply from the device.
- Make sure that the electric installation protection against accidental contact adheres to the applicable safety regulations.
- Pay regard to the local regulations and circumstances regarding electrical installations.
- Repairs should only be carried out by Messkonzept.

## 1.2 Safety instructions for use in explosion hazard areas Zone 2

Conformity with DIN EN 60079-15 "Explosive atmospheres - Part 15: Equipment protection by type of protection "n" : 2011-02 and 2020-03" was proven with report no. 2.12BR190104AUG2V06 "Bericht zur Eignung des Standardgehäuses der Messgeräte FTC3xx und FTC4xx für Zone 2, Schutzart „nR“, schwadensicheres Betriebsmittel"<sup>1</sup>. If flammable gas is fed into the analyzer at overpressure, a leak in the gas path could result in an ignitable mixture in the analyzer housing. To prevent the formation of an explosive atmosphere in the device itself even in the event of a leakage, the housing is internally filled with glass beads which, due to their filling density, leave only a small free volume of about 0.15l in the housing. Moreover, due to the small size of the glass beads, this free volume is fragmented into such small sub-volumes that a flame cannot spread. **Therefore the device may only be opened by the manufacturer.**

## 1.3 Intended Use

- Messkonzept GmbH does not assume any liability in case of improper handling of the measuring device. Improper handling can cause hazards due to malfunction of the measuring device.
- The FTC-series of gas analyzers offer high-precision measurement and detection of non-corrosive, dust-, condensate-, aerosol and oil mist-free gases unless the design of the equipment is explicitly declared to be suitable for this purpose. Please contact [info@messkonzept.de](mailto:info@messkonzept.de) for detailed information and solutions.

---

<sup>1</sup>Report on the suitability of the standard housing of the FTC3xx and FTC4xx measuring instruments for Zone 2, protection type "nR", steam-proof equipment

- The specifications listed in the appendix of these operating instructions reflect the conditions under which the products described here may be operated. Individual requirements resulting from the customer's measuring task are determined and recorded with the Measuring Task Questionnaire (German: Messaufgabe 2.01.1FB180619MPL1V007, English: Measuring Task 2.01.1FB180619MPL1V007). Requirements that are not specified by the customer in the questionnaire are not taken into account in the mandatory evaluation of the measuring task by Messkonzept GmbH. In the evaluation of the measurement task by Messkonzept GmbH, it is also recorded whether the measurement task can be carried out with the proposed devices. In addition, restrictions can be demanded by Messkonzept GmbH, which must then be implemented by the customer. These restrictions can include, for example, special conditioning of the measuring sample by filter measures and measuring gas coolers or specifications of the pressure and flow rate ranges.
- FTC-series gas analyzers do not have a metrology marking in the sense of EU directive 2014/32/EU. They can, therefore, also not be used in medical or pharmaceutical laboratory analyses or in the manufacture of pharmaceuticals in pharmacies based on a doctor's prescription.
- The device must not be used in hazardous areas of explosion protection. Only FTC320 measuring instruments marked EX II 3G Ex nR IIC T4 Gc are suitable for use in ATEX- Zone 2.
- **Combustible gases:** The inner gas line of the detector is checked for leaks. The supply of flammable gases is permitted, but the tightness of the connections and the detector must be checked before commissioning and regularly during operation. Gas leaks can cause an explosive atmosphere! We strongly recommend that you select the "Glass bead filling" option. You can find out whether your appliance is equipped with this option in the manufacturing protocol under "Glass bead filling". If the appliance is equipped with this option, the build-up of an explosive atmosphere inside the appliance is limited by tightly filled glass beads (Ø0.6mm) inside the housing.
- **Ignitable gases:** Our appliances are designed in such a way that ignition will not occur if gases up to temperature class T3 are supplied during correct operation; the maximum surface temperature is below 200 °C. A fault in the appliance can lead to ignition. Users of our appliances must always carry out an individual risk assessment before use, from which the necessary protective measures must be derived and implemented. The use of flame arresters as part of the individual concept for handling flammable mixtures is strongly recommended. We will be happy to provide you with an individual quotation if you require flame arresters.
- Check the function and tightness of our gas detectors, the connections and piping and the protective devices after installation and then at regular intervals during operation, especially in the event of severe stresses, such as shocks, vibrations, and corrosive attacks from inside or outside. If you detect or suspect a malfunction in one of our gas detectors or the protective device, immediately disconnect the affected gas detector from the power supply and stop the gas supply immediately.
- The housing of the FTC320 must never be opened, in particular in case of devices filled with glass beads. After opening, the necessary filling density is no longer given. The guarantee becomes void if you open the housing of the FTC320.
- The device and cables must be effectively protected from damage and from UV light (protective roof when installed outdoors).



- The gas path inside the device is free of oil and grease and suitable for applications with pure oxygen ("Cleaned for Oxygen"). For such applications, contamination, such as that caused by the introduction of not oil-free compressed air, must be avoided.
- The cables must be connected voltage-free. Do not disconnect while energized!
- Permissible ambient temperature (when used as intended): -5 to +50 °C.
- A fixed wall mounting must be provided. The device is only to be mounted in areas with low mechanical hazards, such as analysis rooms, in other words, rooms in which no heavy work is performed. In areas with high mechanical hazards, such as workshops, transport routes, production facilities for heavy equipment or construction sites, etc., additional protection against external damage is necessary, e.g., by means of a protective cabinet.
- The device may only be used in an area with pollution degree 1 (according to DIN 60664-1).
- Avoid accumulation of dust on the device! Regular inspection of the housing and cables with regard to mechanical damage is mandatory. In atmospheres that strongly attack plastics, the front foil must also be checked for cracks and discoloration, especially in the area of the buttons. If damage occurs, the device must be taken out of operation and the manufacturer must be contacted.

Note: Please keep this manual for future use.

### 1.3.1 Disposal instructions

The device must not be disposed of in the residual waste garbage can. If the appliance is to be disposed of, please send it directly to us (with sufficient postage). We will dispose of the properly and in an environmentally friendly manner.

## Chapter 2

# Principle of Measurement

### 2.1 Determining Concentrations via Thermal Conductivity

Thermal Conductivity Detectors (TCD) have been used in the chemical industry since the 1920s as the first process gas analyzers for the quantitative composition of gas mixtures. Every gas has a unique heat conductivity that is governed by its molar mass and viscosity. The measurement is based on the principle that the thermal conductivity of a gas mixture is dependent on the thermal conductivity of its gas components and their fractional amounts in the mixture. Thus, the concentrations of different components of a gas mixture can be calculated from thermal conductivity.

The main advantage of the TCD's measurement principle compared with the widespread infrared analysis technique is that it is not limited to gases with a permanent dipole moment. It can identify noble gases (He, Ar, Ne, etc.) as well as homonuclear gases such as H<sub>2</sub> and N<sub>2</sub>. Furthermore, it is robust and cost effective.

The principle of thermal conductivity measurement works best if the analyzed gas components' thermal conductivity varies greatly. For TC measurement-based analysis, one of the following conditions must be met:

- The mixture contains only two different gases (binary mixture), e.g., CO<sub>2</sub> in N<sub>2</sub> or H<sub>2</sub> in N<sub>2</sub>
- The thermal conductivity of two or more components is similar but different than that of the measuring gas, e.g., measuring H<sub>2</sub> or He in a mixture of O<sub>2</sub> and N<sub>2</sub> (quasi binary mixture)
- The mixture contains more than two gases and the volumetric fractions of all but two components (or component groups) are constant over time
- The mixture contains more than two gases, of which all but two components' concentrations can be determined through other measurement principles (as employed in the FTC400 through cross-sensitivity compensation of IR- and TC-sensor information).

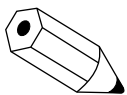

The thermal conductivity of gases rises with temperature and the slope of the increase with temperature is different for different gases. Upon request, it can be checked whether the temperature of heat sink and/or source should be changed in order to improve the accuracy or to avoid cross-sensitivity effects.

Cross-sensitivity is the sensitivity of the measurement on other gases than the measured component. Perturbation-sensitivity means the sensitivity of the measurement to other influences than the gas-composition, e.g., the gas pressure.

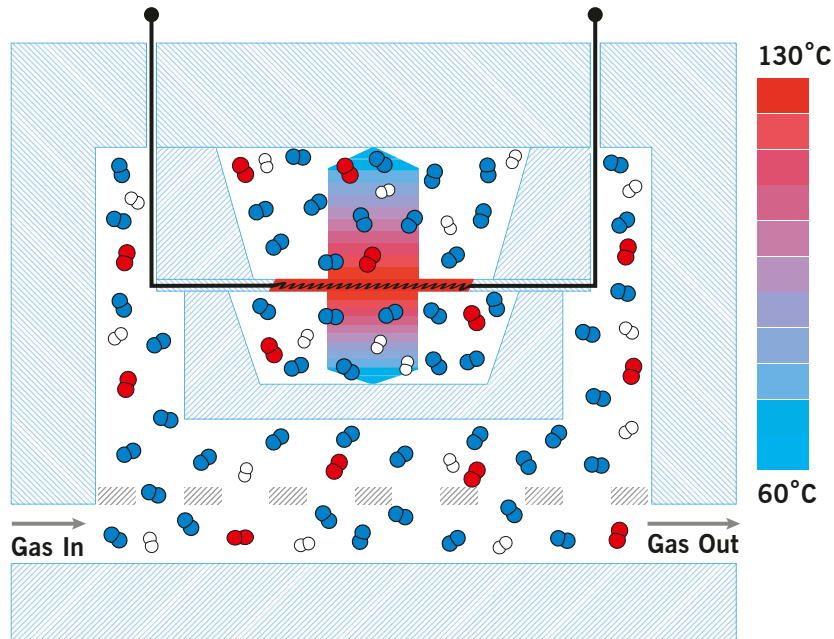

Figure 2.1: Schematic drawing of thermal conductivity measurement. The sensor is comprised in the stainless-steel block which is kept at a constant temperature.

The FTC320 contains a thermal conductivity sensor that analyzes the quantitative composition of gas mixtures. The measurement is based on the heat transfer between a heat source and a heat sink.

The measuring gas is led through a stainless-steel block that is kept at a constant temperature of 63°C (for most applications). The block temperature is stabilized using a control loop - it serves as a heat sink of constant temperature. A micro mechanically manufactured membrane with a thin-film resistor serves as a heat source. A control loop stabilizes the membrane temperature at 135°C (for most applications).

Above and below the membrane two small cavities are etched into the silicon. These cavities are filled with measuring gas by diffusion. The surfaces opposite the membrane are thermally connected with the heat sink. Through maintaining a constant temperature gradient between the two opposite surfaces, the heat flow is dependent on the gas mixture's thermal conductivity alone. Hence the voltage needed to keep the membrane temperature constant is a reliable measure for the thermal conductivity of the mixture and can be used further to determine the gas mixture's composition.

Measuring Gas	Carrier Gas	Basic range	Smallest range	Smallest suppressed zero range	Multi Gas Mode
H <sub>2</sub>	O <sub>2</sub>	0% - 100%	0% - 0.5%	98% - 100%	Yes
H <sub>2</sub>	N <sub>2</sub> / air	0% - 100%	0% - 0.5%	98% - 100%	Yes
H <sub>2</sub>	Ar	0% - 100%	0% - 0.4%	99% - 100%	Yes
H <sub>2</sub>	He	20% - 100%	20% - 40%	85% - 100%	On request
H <sub>2</sub>	CH <sub>4</sub>	0% - 100%	0% - 0.5%	98% - 100%	On request
H <sub>2</sub>	CO <sub>2</sub>	0% - 100%	0% - 0.5%	98% - 100%	On request
He	N <sub>2</sub> / air	0% - 100%	0% - 0.8%	97% - 100%	Yes
He	Ar	0% - 100%	0% - 0.5%	98% - 100%	Yes
CO <sub>2</sub>	N <sub>2</sub> / air	0% - 100%	0% - 3%	96% - 100%	Yes
CO <sub>2</sub>	Ar	0% - 100%	0% - 20%	50% - 100%	Yes
Ar	N <sub>2</sub> / air	0% - 100%	0% - 3%	97% - 100%	Yes
Ar	CO <sub>2</sub>	0% - 100%	0% - 50%	80% - 100%	Yes
CH <sub>4</sub>	N <sub>2</sub> / air	0% - 100%	0% - 2%	96% - 100%	Yes
CH <sub>4</sub>	Ar	0% - 100%	0% - 1.5%	97% - 100%	Yes
O <sub>2</sub>	N <sub>2</sub>	0% - 100%	0% - 15%	85% - 100%	Yes
O <sub>2</sub>	Ar	0% - 100%	0% - 2%	97% - 100%	Yes
N <sub>2</sub>	Ar	0% - 100%	0% - 3%	97% - 100%	Yes
N <sub>2</sub>	CO <sub>2</sub>	0% - 100%	0% - 4%	97% - 100%	On request
NH <sub>3</sub>	H <sub>2</sub>	0% - 100%	0% - 5%	95% - 100%	On request
CO	H <sub>2</sub>	0% - 100%	0% - 2%	99.5% - 100%	On request
SF <sub>6</sub>	N <sub>2</sub> / air	0% - 100%	0% - 2%	96% - 100%	On request

Table 2.1: Measuring ranges of typical gas compositions for analysis with the FTC320, concentrations are given in Vol.%.



As mentioned in section 1.3, explosive gases should not be led into the device without suitable protective measures. It is the responsibility of the user to prepare a risk assessment and to derive suitable protective measures from it.



For flammable gases, such as  $H_2$ ,  $CH_4$ , etc., the use of a FTC320 with the option “glass-beads filling” is strongly recommended. If a mixture of a combustible gas with an inert gas is present in a mixing ratio such that even adding any amount of air will not make the mixture explosive, it is called totally inert. Totally inert gas mixtures may be introduced into a FTC320 device without glass ball filling.

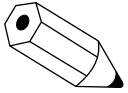

“Basic range” is the largest possible measuring range and is set by default. The linearization is performed over the basic range. The smallest measuring ranges at the beginning and the end of the basic range are facilitated through specific calibration. The smallest possible range between the basic range and the smallest ranges at the end beginning and the end of the range can be estimated by linear interpolation.

The Multi Gas Mode (MGM) is a configuration that allows for the consecutive measurement of different gas pairs. The gas pair can be switched through the control panel or via the RS232-interface. Gas pairs labeled “Yes” in Table 2.1 are commonly used. Gas mixtures labelled “On request” can also be implemented upon request.

### 2.1.1 FTC320 Detector Unit

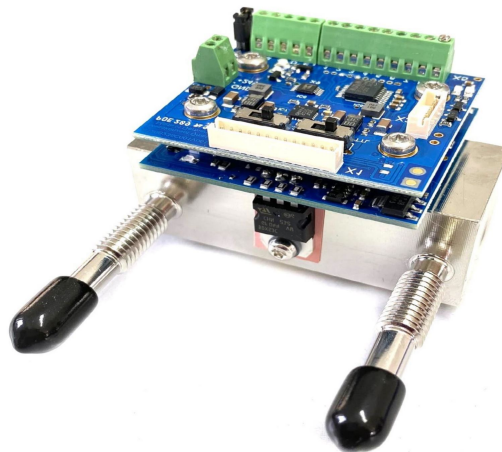

Figure 2.2: FTC320 Detector Unit

The FTC320 is a highly precise and stable Thermal Conductivity Detector (TCD) that is designed for use as a gas detector. The unit consists of a hermetically sealed pressure proof stainless-steel block with a gas duct. Sample gas entering through the gas inlet is guided to the micro-mechanical thermal conductivity sensor and further downstream to the outlet port. The pneumatics are designed to minimize the influence of a changing gas flow. The operating temperature of  $63^{\circ}C$  is stabilized by a highly accurate PI control loop.

In order to avoid electrical interference on the measuring output, the high-performance analog adaption circuit is directly mounted on top of the stainless-steel block. The Processor board digitizes the signal in a 24bit A/D converter. The micro-controller performs all calculations, such as linearization, calibration, and cross sensitivity compensation directly on the detector unit.

## 2.2 Calibration

This section explains how the readjustment of the device should be planned and carried out on site. Different installation, dew point, pressure, flow rate and test gas quality can lead to a shift in the indication right from the start. In addition, the reading may vary by 2% of the smallest measuring range per week, e.g., measuring H<sub>2</sub> in N<sub>2</sub>, the drift per week may be 100 ppm.

**Read the following pages before beginning the actual calibration routine!** Only afterwards proceed to section 7.2 where calibration via the display interface will be explained.

### 2.2.1 Offset and Gain Calibration

The aim of calibration is to ensure that the measured concentration matches the specified test gas concentration. This is achieved by the correct adjustment of two calibration parameters, called **Offset** and **Gain**, which correspond to the ordinate intercept and the slope of a linear equation calculated in the device. Figures 2.3 and 2.4 explain how offset and gain correction works.

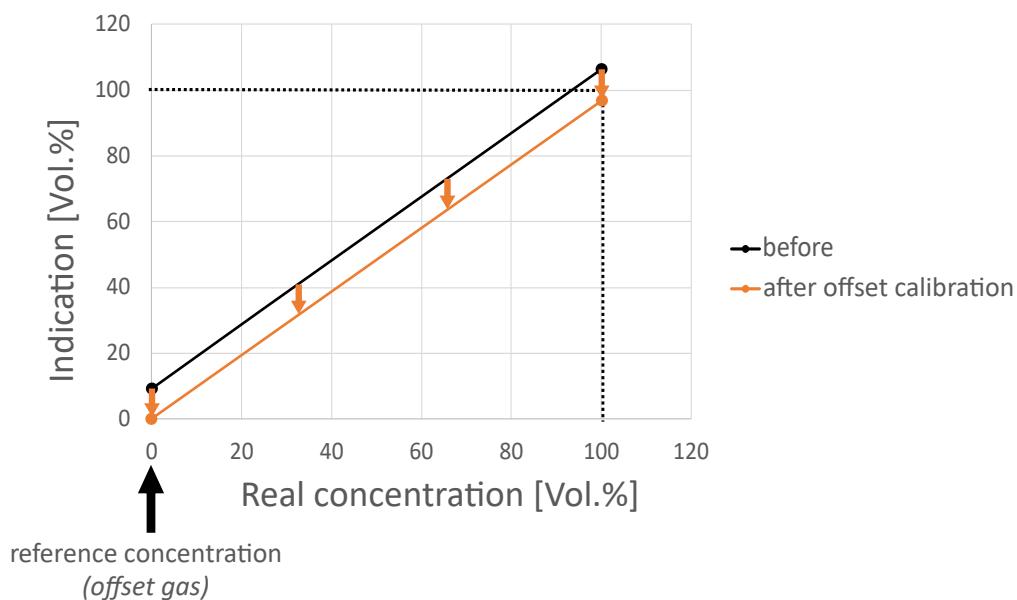

Figure 2.3: Offset calibration

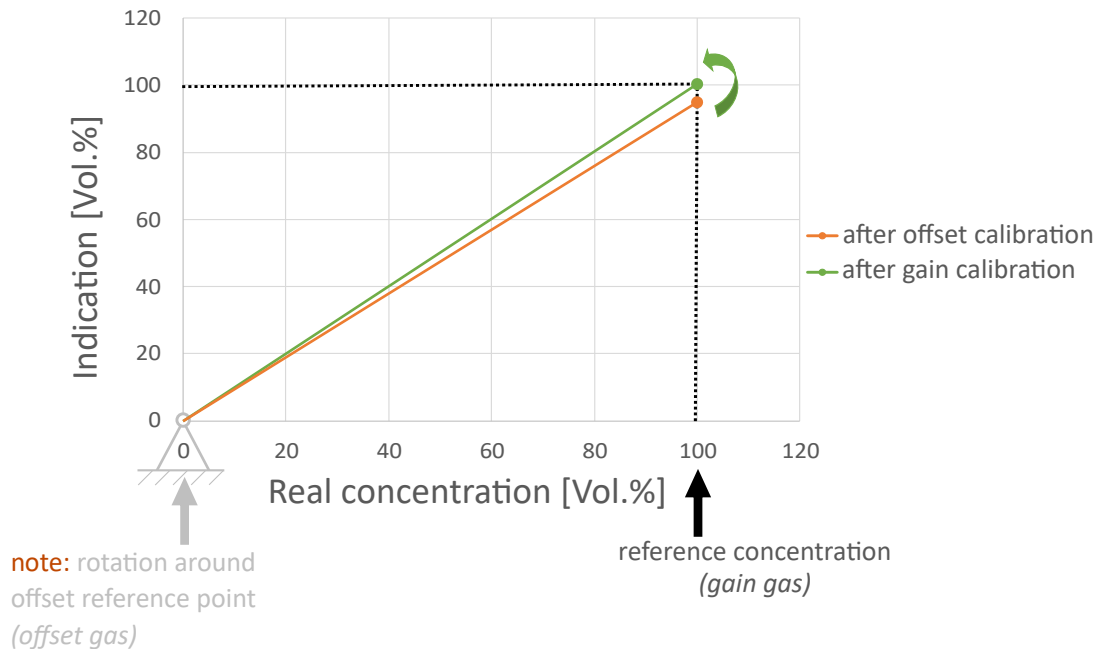

Figure 2.4: Gain calibration after offset calibration

For a determination of offset and gain a two-point calibration must be performed. The concentration of the offset test gases should be close to the start-point and the concentration of the span (Gain) test gas should be close to end-point of the measuring range - a difference of  $\pm 10\%$  of the measuring range from the start- or end-point is permissible. For instance, when measuring H<sub>2</sub> in O<sub>2</sub> at a measuring range from 0 Vol.% – 100 Vol.%, use pure O<sub>2</sub> as offset test gas (Offset Gas = 0 Vol.% H<sub>2</sub> in O<sub>2</sub>) and pure H<sub>2</sub> as the gain test gas (Gain Gas = 100 Vol.% H<sub>2</sub> in O<sub>2</sub>).

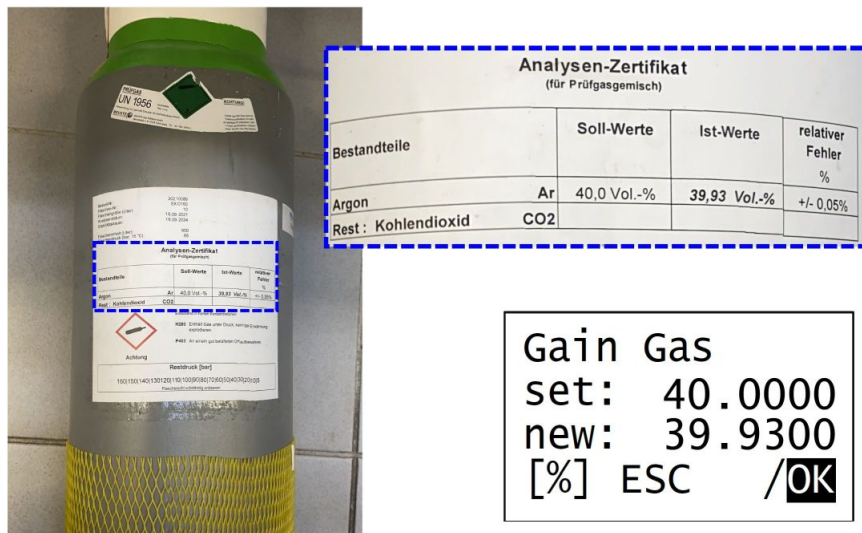

Figure 2.5: Setting the actual gas concentration of a test gas bottle as reference concentration for gain calibration

A two-point calibration always requires an offset calibration directly before a gain calibration! **A one-point calibration, in which only a new offset value is determined, is sufficient in most cases.** It is suitable for correcting drift or changes in operating parameters such as flow rate, pressure, or dew point. Compared to the offset, the gain is stable over years and practically unaffected by changes in flow or pressure. In the case of a pure offset calibration, a test gas with any concentration in the measuring range can be used but must be set before starting the offset calibration.

### 2.2.1.a Performance check with test gas

During a performance check, the response of the device to a test gas that is within the measuring range is monitored and recorded. In contrast to a calibration, the settings of the device are not changed. An inspection of the recorded performance test might uncover phenomena that can be obscured by repeated calibration. This applies, for example, to a persistent signal drift or a periodicity in the signal curve due to unsteady flow, pressure, or dewpoint. The correct indication of the test gas is almost always sufficient to prove that the device is working properly.

### 2.2.1.b Test Gas Quality

A test gas of sufficient quality for your application should be used for performance testing and calibration. For calibration, Messkonzept uses gases with the following purities:

H <sub>2</sub>	He	N <sub>2</sub>	Ar	O <sub>2</sub>	CO <sub>2</sub>	CH <sub>4</sub>
5.0	5.0	5.0	4.6	4.5	4.5	3.5

Table 2.2: Recommended calibration gas purities for measurements of high precision

The gas purities are selected such that the devices comply with the specifications for the smallest measuring range. Messkonzept recommends gases of the same purity for on-site calibration. If your own requirements differ, please choose the appropriate gas purity. Please contact Messkonzept if you would like advice.

### 2.2.1.c Criteria For Test and Calibration

Carry out a test or calibration under - as far as possible - similar physical conditions to those used for the measurement, e.g. pressure, flow, temperature, filtration, dew point, etc.

A performance test and, if necessary, calibration with test gases is required if one of the following criteria is met:

- After new installation of the device or after it was serviced.
- After changes to the sample preparation system and outlet that affect, for example, pressure, flow, temperature, filtration, dew points, etc.
- In a regular cycle, depending on the desired accuracy - but at least once a year! To determine the appropriate time interval, we recommend starting with a more frequent recorded performance test and determining the optimum interval from these results. The time between tests/calibrations can be in the range of:



- months for a measurement task in the basic or medium measuring ranges.
- days to weeks for small measurement (low- or sub-vol%) ranges.
- directly before each measurement if maximum accuracy is required.

### 2.2.1.d Gas supply during calibration

Ensure that the appropriate test gas has fully entered the device before performing an offset or gain calibration. You should monitor the signal for stability to ensure this. After activating the calibration routine, a sampling phase of 10 seconds begins. Keep the gas supply stable and continuous during this phase.

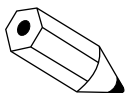

Please note that any large change in flow, pressure or concentration, for example when opening a valve for the test gas flow, will cause a certain disturbance to the thermostated measurement in the FTC320. This is particularly the case if you accidentally had a very high gas flow, even for a very short time. It may a while for the temperatures in the FTC320 to reach equilibrium again and for the measurement indication to provide a stable and reproducible value in the ppm range. For measurements of the highest precision, this can take 10-20 minutes, see Figure 2.6.

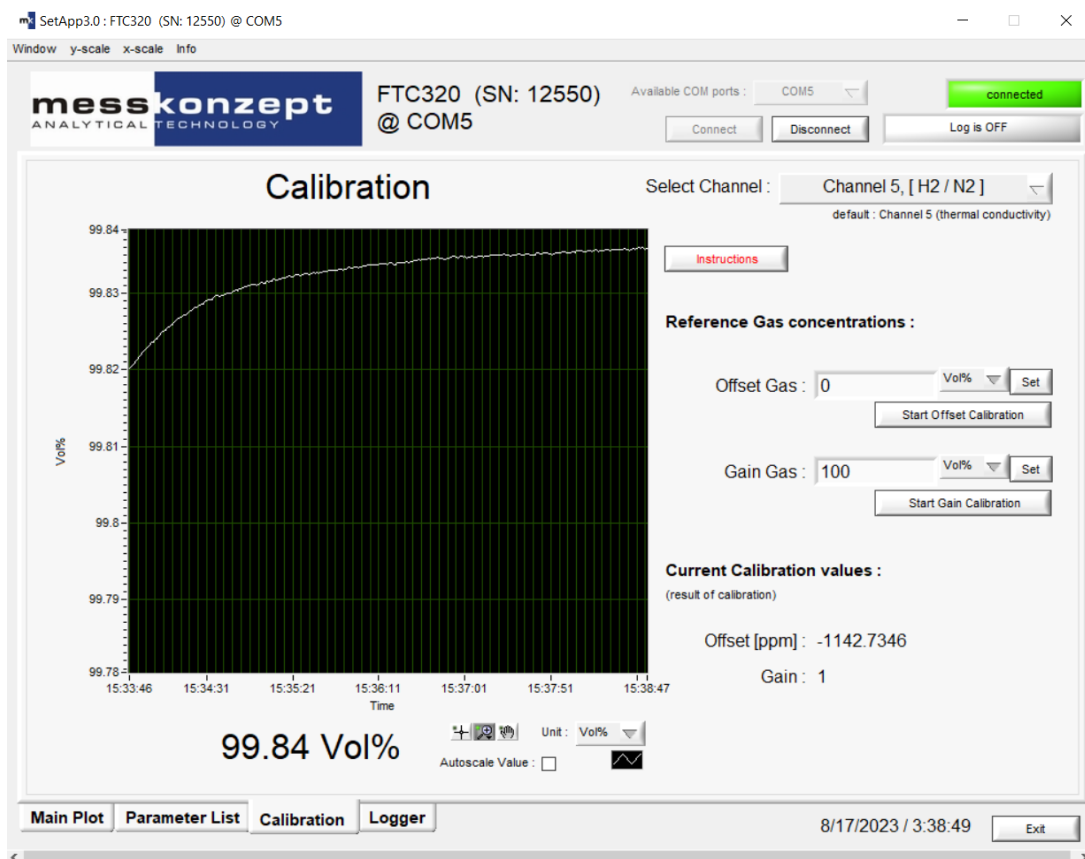

Figure 2.6: After a sudden change in flow, pressure or gas concentration it may take some minutes for the measurement to stabilize to ppm precision

## 2.2.2 Performing Calibration

### 2.2.2.a Calibration via the display panel

The calibration can be performed conveniently via the display interface. The procedure is explained in section 7.2.

### 2.2.2.b Remote Control Calibration via Serial Interface

Adjustment of the test gas concentrations used, and calibration is a function in the free Windows based app **SetApp3.0**. Please revise chapter **Calibration** in the manual **SetApp3.0: Laboratory Software**.

A terminal emulator, e.g. Tera Term, can be used for adjustment of the test gas concentrations used and activating of the calibration. Please contact Messkonzept for the structure of the necessary command.

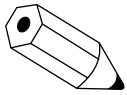

Always do an offset calibration first before doing a gain calibration!  
In most cases an offset calibration alone is sufficient for the proper performance of the device! First check if there is a deviation before possibly calibrating!

## 2.2.3 Use of Substitute Gases

Instead of using toxic or explosive gases for calibration, substitute gases may be used. A substitute gas has (at a certain concentration) the same thermal conductivity as the test gas it is substituting, such it can also be used for the calibration instead. Please contact Messkonzept for details on possible substitute gases for your application.

## Chapter 3

# Installation of the Instrument

### 3.1 Mounting of the FTC320

The FTC320 is designed for wall fastening. The four mounting holes are shown in Figure 3.1. M4 cylinder head bolts are suitable. Please remember to keep additional space for adequate assembly of gas hoses and cables (see Chapter 10 "Appendix: Dimensional Drawing" for more information).

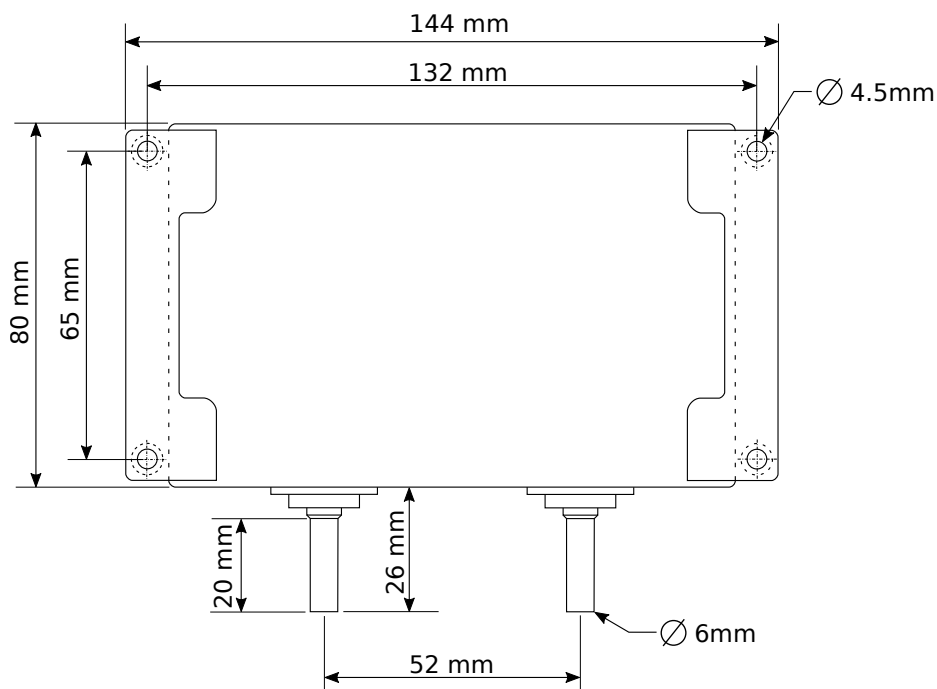

Figure 3.1: Mounting holes shown from the rear side of the housing.



If you are planning to lead flammable or toxic gases into the device, the device must be installed in a well-ventilated area. All devices undergo a leakage test during production, nevertheless a limited release of small gas quantities is possible.

## 3.2 Gas Ports

On the bottom of the FTC320 housing two tubes with 6mm outer diameter for gas connection are located. They are labeled with "GAS IN " and "GAS OUT".

For low requirements regarding gas tightness and resistance to pressure, the tubes can be used as hose connectors. For permanent gas and pressure tightness compression fittings are recommended (e.g. by "Swagelok"®).

After connecting the device, a leakage test should be performed (especially when working with flammable and/or toxic gases).

## 3.3 Leakage Test

After connecting the gas pipes, a leakage check of the joints must be carried out, e.g. with foam-forming agents (soap solution or leak detection spray). The test is to be carried out at an overpressure of at least 1 bar or the pressure expected in operation (max. 3 bar abs.) if this is higher.

The internal gas path of every FTC320 for use in potentially explosive atmospheres is tested for leakage during production at a pressure of 4 bar for a holding time of 30 minutes.

### 3.3.1 Housing Seal

The housing leakage test is performed as a routine test according to DIN EN 60079-15:2020-03, section 12.2.2.1.2. The interior of the housing is filled with glass beads to minimize the internal free volume. **Therefore the device may only be opened by the manufacturer. Unauthorized opening will render the instrument unsuitable for use in zone 2.** Regular replacement of the silicone seal is not necessary, but it is recommended that the manufacturer checks the tightness of the housing every 5 years. If the unit is installed in atmospheres that are highly corrosive to plastics, it is recommended to have the inspection carried out more frequently.

## 3.4 Electrical Connectors and Ground

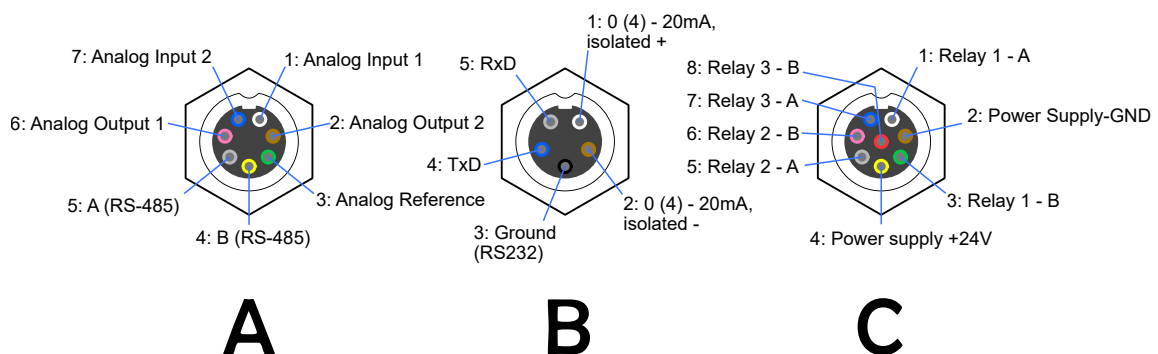

Figure 3.2: Electrical connector pin assignments of the three connectors on the FTC320

The FTC320 has three plug connectors as shown in Figure 3.2. The cables (712, IP67) with molded connector plug and a length of two meters (five meters available on request) are part of the purchased

parts package. The cables have open ends. The cross-section of the conductors in cable A and C is 0,14mm<sup>2</sup>, for cable B 0,25mm<sup>2</sup>. Cable A for connection of the analog voltage signals is shipped upon request.



The protection class of the device is only effective with all cables attached. In case cable A is not used, connector plug A must closed with an end fitting.

### 3.4.1 Requirements for Electrical Connections



Before using the device make sure that the power supply is in accordance with the specifications of the device and that all electric connections correspond to the information given in this manual.

The FTC320 is a device of protection class III. For power supply a source with PELV specification (Protective Extra Low Voltage) according to EN 60204-1 must be used. See also Section 3.4.2 "Ground". The potential-free relay contacts must also be monitored with a power supply unit with PELV specification.

### 3.4.2 Ground

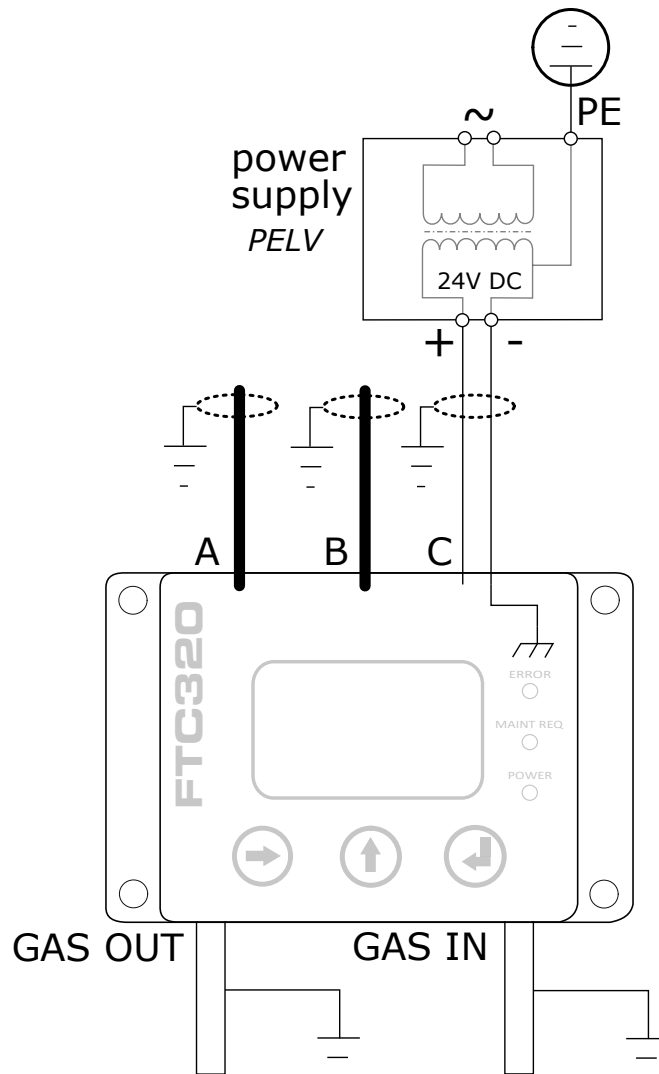

Figure 3.3: Grounding the FTC320

To comply with EN 60204-1 and to ensure your device's function, the device has to be installed such that GND on the low-voltage side of your 24V power supply is connected to protective earth (PE), see Figure 3.3. Some power supplies are internally wired like this already.

Inside the FTC320 there is a connection between GND and the device casing, also the gas duct is connected to GND.

The shielding of cables A, B and C should be connected to functional ground. Dependent on the local circumstances, gas inlet and gas outlet can be grounded additionally. Connections to ground should be made with short wire (at least wire 15 AWG or 1.5 mm<sup>2</sup>).

### 3.4.3 Data exchange via serial interface (RS-232)

The serial interface, often called UART (Universal Asynchronous Receiver Transmitter), is based on the RS-232 standard. The point-to-point data transmission is carried out via the two TxD (Transmit Data) and RxD (Receive Data) wires to be crossed with a common ground line (GND) for both devices. This creates a bidirectional bus that allows full-duplex communication. The communication partners can therefore send and receive data simultaneously.

Data transmission via UART is performed with a fixed data frame (UART frame). This frame must be known to both communication partners. It consists of: A start bit, 5-9 data bits, an optional parity bit and one or two stop bits. If a PC is connected to the analyzer, the necessary settings are typically identified automatically. If this is not the case, the parameters can be set manually according to Table 9.3. (see Section 9.1).

Only a few PCs are still delivered with a so-called COM port (serial RS-232 interface). To be able to operate and program devices that have an RS-232 interface with computers without this, use of converters from RS232 to USB is advised. The converters often have a 9-pin D-Sub connector as input, but there are also converters with screw terminal connections.

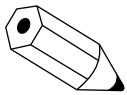

The serial interface allows operation of the instrument and the display and storage of measurement data with the program SetApp 3.0. More information and a link to download the software can be found at [www.messkonzept.de](http://www.messkonzept.de).

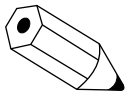

If you plan to develop or use your own software solutions for communication via the RS-232 interface, you may need more detailed information on the available parameters. Please contact Messkonzept in this regard.

## Chapter 4

# The Front Panel

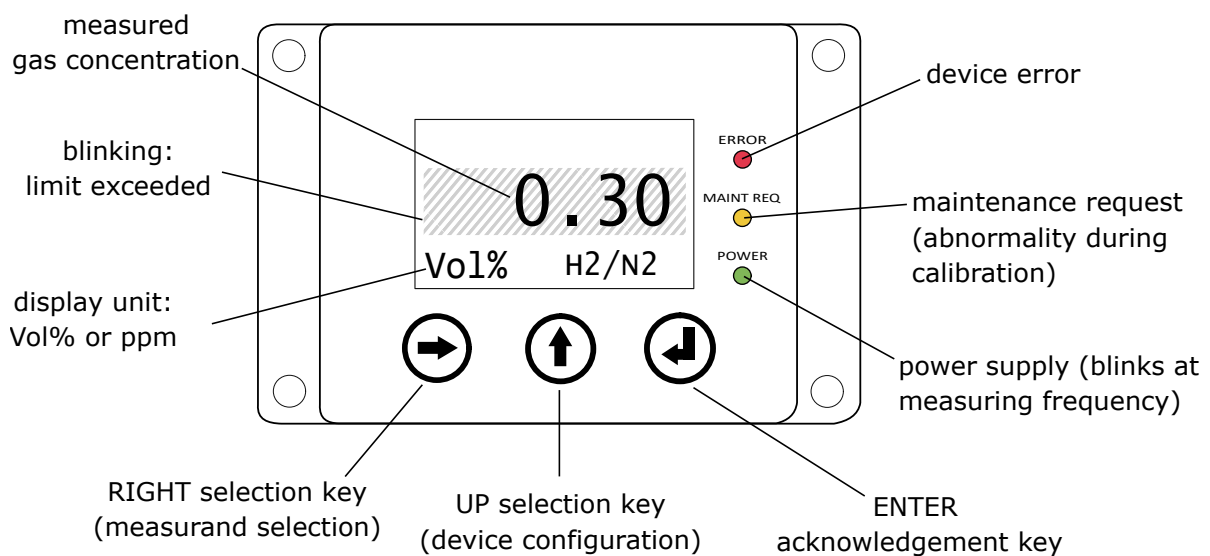
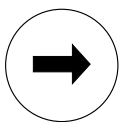

Figure 4.1: Front view schematic of the FTC320 front panel during operation

### 4.1 Display

### 4.2 Keys



#### **RIGHT / Selection Key**

On the operation screen, the <RIGHT> key can be used to select one of the measured variables displayed on the work screen. With the <ENTER> key the menu related to the measured parameter can be called up, in which, for example, the calibration routine of the parameter can be accessed.

The <RIGHT> key enables the operator to scroll through the various menu items of menus and submenus. The currently selected menu item is marked by black background and is called with the <ENTER> key.

In submenus requiring numerical inputs, the <RIGHT> key scrolls to the next digit and to “ESC/OK” at the end.





**UP / Selection Key**

In menus or submenus, the <UP> key quits the recent menu and brings you back to the menu above and ultimately to the main menu.

To quit menus with an "ESC/OK" option, select one of these fields with the <RIGHT> key and confirm with <ENTER>.

In submenus requiring numerical inputs, the <UP> key changes the selected digit.



**ENTER / Termination Key**

The <ENTER> key calls the item that is marked as selected. Menu items are selected by the <RIGHT> key. In submenus with an "ESC/OK" option the <ENTER> key confirms the selection of "ESC" or "OK".

## Chapter 5

# Instrument display

This chapter describes the device start-up routine. The warm-up screen, see Figure 5.1, shows the set temperature and actual temperature of the instrument during warm-up. After the warm-up, the device switches to the operation screen, see Figure 5.2. From the operation screen the main menu can be opened.

Note: To make device-specific settings on the device, it is necessary to enter an Expert code (preset to 222.0000).

### 5.1 Warm-up Screen

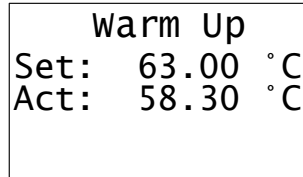
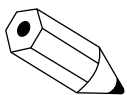

Figure 5.1: Warmup screen of the FTC320

The warm-up screen shows the current block temperature during warm-up (see „Act:“ in the figure above). The target value of the block temperature, 63 °C for the standard version or 70 °C for the high temperature version, is shown as the Set-value.



Pressing the <UP> key during warm-up switches directly to the operation screen and activates the current loop. The displayed concentration value will not be precise until the needed block temperature is reached.

### 5.2 Operation Screen

After warmup the operation screen is shown (see Figure above). Depending on the version of the instrument, either one measured value or several measured values are displayed on the working screen. From the operational screen the main menu can be opened using the <UP> key.

### 5.2.1 Display of one measured value

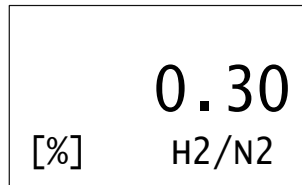

Figure 5.2: FTC320 operation screen (one measured parameter)

In the center of the display the currently measured gas concentration is shown, the associated unit of the measurement (ppm or Vol.%) is indicated in the bottom left corner of the operation screen. The currently measured gas pair, e.g. "H2/N2" for hydrogen in nitrogen, can be found in the bottom right corner of the display. The display resolution in ppm is 1 ppm, the number of digits displayed in Vol.% indication is adjusted according to your requirements upon shipment (can be changed manually in the Expert mode, see Sections 6.3.1 and 6.5.1).

Pressing the <UP> button calls up the main menu.

Pressing the <RIGHT> button and then pressing the <ENTER> button calls up the measured variable-related menu.

### 5.2.2 Display of several measured values

H <sub>2</sub>	2.58	%
CH <sub>4</sub>	28.10	%
CO <sub>2</sub>	16.87	%
N <sub>2</sub>	52.45	%

Figure 5.3: FTC320 operation screen (several measured parameters)

Each line of the display is assigned to a measured variable whose designation is shown on the left side, for example "O<sub>2</sub>" for oxygen or Pr. for pressure (for devices with pressure sensor). The value of the measured variable is shown next to it on the right. The associated units (Vol. %, ppm, bar, etc.) are displayed on the right side of the display. When displayed in Vol.%, the number of decimal places displayed can be selected (preset according to customer requirements, modification requires Expert Mode, see Section 6.3.1).

## Chapter 6

# General instrument settings

### 6.1 Top Level Main Menu

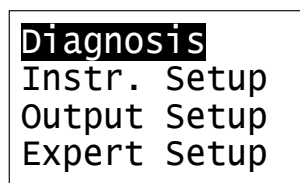

Figure 6.1: main menu of the FTC320

The main menu of the general instrument settings can be accessed from the operation screen (display of measured values) by pressing the <UP> key. Pressing the <UP> key again will take you back to the working screen.

Other submenus are accessible from the main menu. To select the following menu item in the main menu, press the <RIGHT> key. Pressing the <ENTER> button selects the highlighted menu item with a black background and opens the submenu.

The menu paths shown in the following chapters all start from the main menu.

### 6.2 Diagnosis

The FTC320 has several integrated diagnosis and test functions that can be accessed through the diagnosis menu. The menu provides the following functions:

- A parameter menu in which device-internal parameters/variables can be read out
- An error menu in which pending errors are listed

### 6.2.1 Parameter Menu

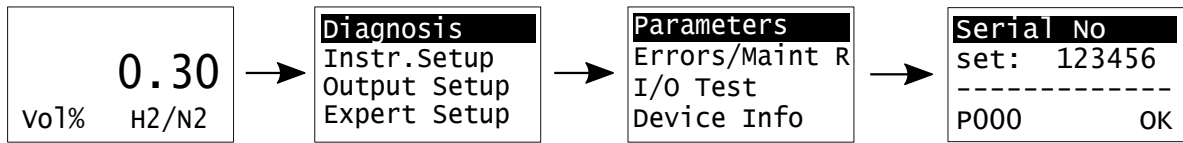

Figure 6.2: parameter menu for advanced diagnosis

The configuration of the FTC320 is defined by a list of internal parameters. The “Parameter“ menu gives read-only access to these parameters. This may help an experienced user to diagnose malfunctions caused by wrong settings. The parameter menu allows you to scroll through the entire parameter list. Contact Messkonzept for detailed information on the listed parameters. The first display line contains the name of the parameter, in the second line the parameter value is shown. The last line shows the parameter index. To move forward in the list, press <ENTER>, to move backwards, press <Up>. To leave the parameter menu mark <OK> by pressing <RIGHT> and confirm with <ENTER>. Some parameters can be changed in the expert setup, see Section 6.5 for more information.

### 6.2.2 Errors and Maintenance Requests

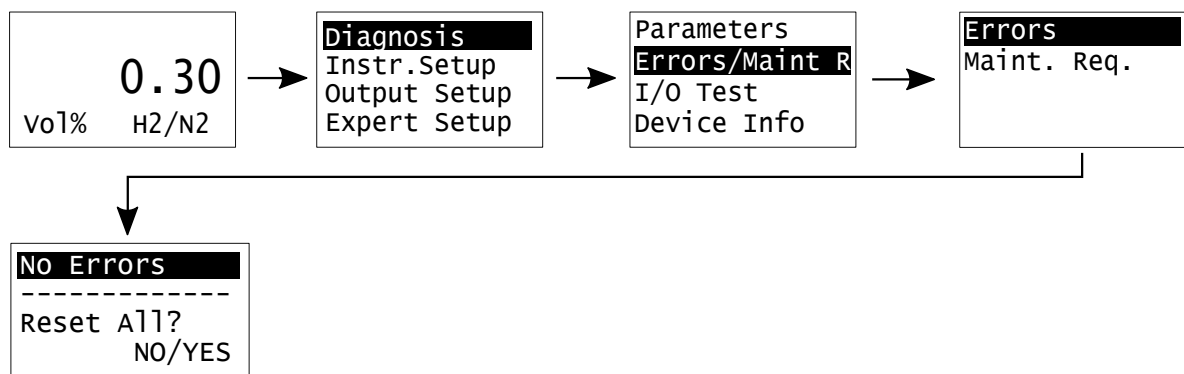

Figure 6.3: Error and Maintenance Request menu

During operation and calibration, the operating parameters and calculated values are checked for plausibility. If one or more values exceed their tolerance range, this is signaled by one of the LEDs next to the display (depending on the deviation by the red "Error" LED or orange "Maint Req" LED). For a list of all possible errors and tolerances, see Chapter 8 "Appendix: System Errors".

A distinction is made between the categories:

- **Error (red LED):** Caution! The device is not ready for operation or is defective! A parameter that is important for the function of the device is outside the acceptable operating range. The device does not work according to the specifications!
- **Maintenance request (yellow LED):** Caution! The function of the device must be checked! This warning is triggered if irregularities have occurred during calibration of the device.

The error menus (Errors and Maint. Req.) show the current error in the first line. If there is more than one error, the next error can be displayed by pressing the <ENTER> button. To navigate backwards

through the list of current errors, press <UP>. If you want to exit the error menu, select either **NO** or **YES** (selection via the <RIGHT> button) and confirm with the <ENTER> button. If you select **YES**, the errors or maintenance requests are reset. This removes the error messages once. If the cause of the error (e.g. defective sensor, block temperature not reached) persists, the error will be displayed again immediately. Maint. Request errors can be permanently reset/acknowledged. Caution: The cause of the error (incorrect calibration) may still be present.

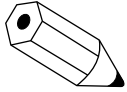

During the warm-up phase, the device is not ready for operation and cannot yet measure with the specified accuracies, therefore the block temperature error "BT MIN(WARMUP)" is displayed until the set temperature of the sensor block is reached (usually within 5-10 minutes). This error can be specifically suppressed if required. If the block temperature has not been reached 20 minutes after starting the device, the error changes to "BT MIN ERROR" and can thus still be taken into account in the event of an error by a warning message or safety shutdown.



Defective devices must be disconnected from the process! This applies for apparent damage of the device such as physical damage but also in the case of unclarified malfunctions in the operation. Separate the device from the process pneumatically (both gas inlet and gas outlet) and remove the power supply from the device.

### 6.2.3 Test of Relays, Analog Outputs and Connections

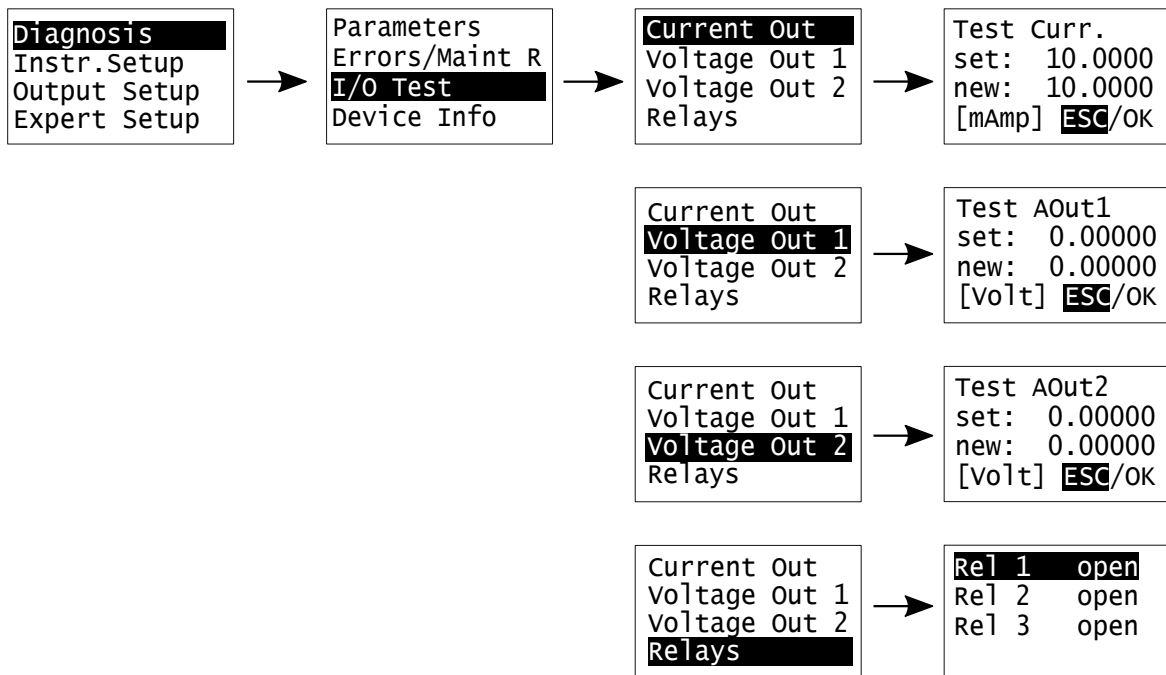

Figure 6.4: I/O Test menu

The “I/O Test” menu provides the opportunity to set the following properties to a defined status in order to test subsequently connected equipment:

- Relay 1 (Rel 1) (open/closed)
- Relay 2 (Rel 2) (open/closed)
- Relay 3 (Rel 3) (open/closed)
- Current of current loop
- Voltage for Analog Out 1
- Voltage for Analog Out 2



Note! All test signals are permanently on until leaving the “I/O Test” menu. It is the responsibility of the expert to assure that I/O tests do not interfere with connected systems and processes in an unintended way.

## 6.3 Instrument Setup

### 6.3.1 Display Unit

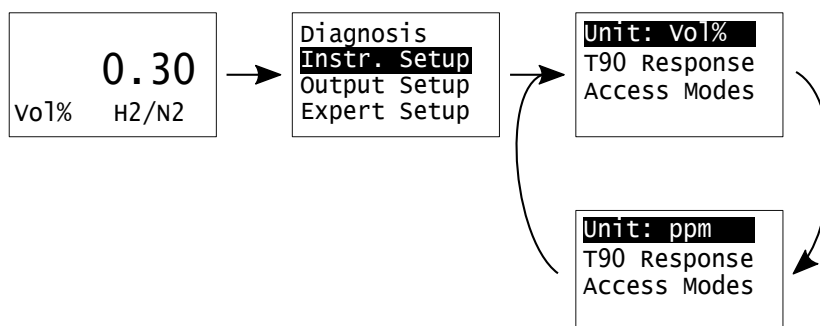

Figure 6.5: changing the displayed unit for gas concentrations.

The first item of the instrument setup menu allows selection of the display unit. Pressing <ENTER> alternates the unit between ppm and Vol.%. Quit the menu with the <UP> key. The value of parameter P56 (see Section 6.5.1) sets the number of digits after the decimals point between 1 and 4 when the display unit is set to Vol.%. The resolution in ppm is always 1 ppm. All internal calculations of the FTC320 are in ppm. Values retrieved through the RS-232 interface will always be in ppm with 1ppm resolution.

### 6.3.2 Response Time Setup

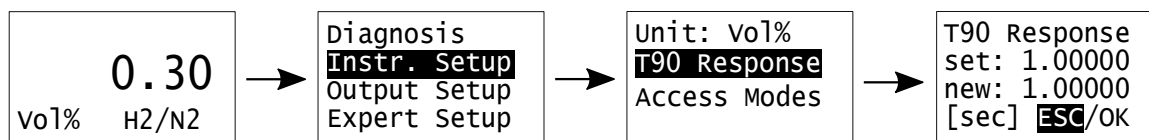
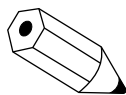

Figure 6.6: T90 response time setup

In the menu “T90 Response” the response time of the exponential filter can be adjusted. The filter reduces the influence of fast variations of the raw signal (signal noise smoothing). The numerical value for the T90 response time is given in the unit of seconds. A range between 0s and 100s is permitted for this value, reasonable values lie between 0.5s to 10s. You can change the numerical value by navigating through the digit position using the <RIGHT> key and changing it using the <UP> key. Confirm by pressing the <UP> key until **OK** is selected. The changed value can be discarded by selecting **ESC** instead. Setting “T90 Response” to 0.0 turns the exponential filter off.



The true response time is influenced by the gas exchange time which depends on the pneumatic installation and the flow rate of measuring gas. A gas flow of 80l/h leads to a gas exchange time of under 0.5s measured from the gas inlet of the device.

Note that the response time in your process depends greatly on the upstream volume before the FTC320. Shorter and/or thinner tubing will benefit response times.



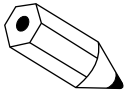

The T90-time is the time in which a sudden change of the measurand (e.g. the gas concentration) reaches 90% of its final value.

### 6.3.3 Access Modes

To protect the FTC320 from unintentional misuse, there are various access levels protected by passwords:

- **User/Operator:** This is the usual state of the device. In this access mode, most device settings can be made via the operating menu and the device can be calibrated. Incorrect operation may put the device in a state in which incorrect measured values are displayed (incorrect calibration), but this state can still be reset. The default user password is 111.000.
- **Expert:** An expert (service technician) can make settings on the device that interfere more deeply with the function of the device, taking the operating instructions and/or instructions from Messkonzept into account. Warning: Careless operation in this access mode can configure parameters in the FTC320 in such a way that it is impossible for the customer to restore the device to its original state or the device may be permanently damaged. The default password is: 222.000.
- **Locked / security mode:** In this access mode, no settings can be made on the device using the operating elements on the display and no calibrations can be carried out. Only after entering the user password (default: 111.000, can be changed in Expert Setup) are the settings on the device enabled again. After unlocking, the device remains permanently unlocked. It may have to be locked again manually.

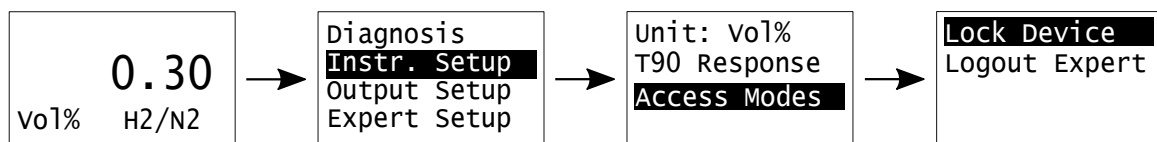

Figure 6.7: Access mode menu in the FTC320

The security mode can be activated via the **Lock Device** menu item in the **Access Modes** submenu, see figure 6.7. To lock the device, the user password must be entered once to ensure that the password is known to the user of the device. The device then returns to the operation screen showing the current measurement value and is then protected against unauthorized accesses. Even after restarting the device, the device remains locked until the correct password has been entered once.

If the device has been set to expert mode by entering the expert password (see Section 6.5), it remains in this mode until the device is restarted. If you want to exit Expert mode manually without restarting, select the menu item **Logout Expert** and confirm with the <ENTER> button. You will now need to enter the Expert password again to access the Expert setup.

The passwords for the various access levels can be changed in the Expert Setup, see Section 6.5.2.

## 6.4 Output Setup

The FTC320 is equipped with three analog outputs:

- One isolated current output with an output range of 0 to 20 mA called **Current Out**.
- Two non-isolated voltage outputs with an output range from 0 to 10 V:
  - **Voltage Out 1**.
  - **Voltage Out 2**.

These analog outputs can be configured from the **Output Setup** menu.

The FTC320 internally uses up to five channels to process different measured gas concentrations, which can be mapped to the analog outputs mentioned above. For each output, a channel can be selected as the signal source. The five channels are typically configured as shown in Table 6.1. Note that your device might only use a sub-set of the 5 channels shown in Table 6.1 and not all of them, depending on the hardware configuration. In this case, the other channels will not output any meaningful data.

Channel (Ch.)	Routed Measurement
1	AUX (O <sub>2</sub> by external electrochemical sensor, H <sub>2</sub> O by humidity sensor, l/h by flow sensor).
2*	Gas concentration by infrared channel IR2.
3*	Gas concentration by infrared channel IR3.
4*	Gas concentration by infrared channel IR4.
5	<b>Gas concentration by thermal conductivity channel.</b>

Table 6.1: The measurement channels and the parameters routed to them. The channel numbers with an asterisk (2\*, 3\*, and 4\*), i.e. the infrared channels, are typically only used in the FTC400!

### 6.4.1 Current Output Setup

The measuring range is typically mapped to a current output of 4mA to 20mA, where a signal of 4mA corresponds to the beginning of the measuring range and 20mA correspond to the end of the measuring range. The current output of the FTC320 can be configured to one of four available current output modes.

If you wish to change the output range (in Vol.% or ppm), see Section 7.4.

In Table 6.2 the four available current output modes are explained, from which you can choose the most suitable one for you. The default setting is the NAMUR compliant mode **4-20mA (Err)** with an error indication through a 3 mA signal, see also Figure 6.10.

output mode	current range	error indication
4-20mA (Err)	output current range: 4-20 mA, minimum: 3.8 mA, maximum: 20.5 mA	freely configurable
0-20mA (Err)	output current range: 0-20 mA, minimum: 0 mA, maximum: 20.5 mA	error value: 21 mA
0-20mA	output current range: 0-20 mA, minimum: 0 mA, maximum: 21 mA	no error indication
Const. Outp.	The output current: a freely configurable constant value between 0-20 mA	no error indication

Table 6.2: The available modes of the current output

The minimum and maximum values given in table 6.2 indicate the absolute limit values of the current signal in regular operation (no errors) when the measurement value rises above or falls below the measurement range, see also *Transition region* in figure 6.10.

Below is a step-by-step instruction on how to adjust the current output:

1. From the **Output Setup** menu, select **Current Out**.
2. A new menu opens with 2 options: **I/O Mode** and **Cal. frozen**. The latter can be toggled between the options **Cal. frozen** and **Cal. active** to determine the behavior of the current output during calibration:
  - **Cal. frozen**: freezes the current output to the last value before calibration in order to avoid unnecessary jumps during e.g. the logging of the current values.
  - **Cal. active**: shows the actual current output during calibration.

The current output settings are, however, found under **I/O Mode**. Clicking <ENTER> after highlighting it opens the menu where the different current output modes can be adjusted.

3. Press <ENTER> on the first display line successively until you reach the desired current output mode (see Table 6.2).
4. **Changing the signal's source**: from the second display line where usually **Ch. 5** is shown, the source of the current signal can be changed. To change the channel, click <ENTER> key multiple times to toggle through the channels until you reach the desired channel (see Table 6.1 for the typical assignment of the channels). The gas measured by thermal conductivity is routed to channel 5 (displayed as e.g. **Ch5. H2** for hydrogen).
5. **Changing the value of the constant output**: in case you chose the **Const. Outp.** mode, you can manually change the value of the constant current output by moving the cursor to the second display line **Const. I-Out**, clicking <ENTER>, and entering the desired value followed by clicking **OK** (see Figure 6.8). If you are not using the current output, it can be set to a constant value of 0.

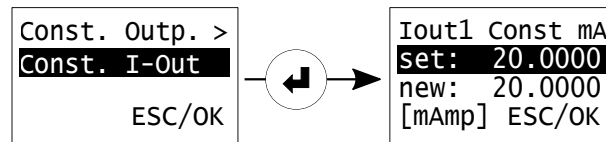

Figure 6.8: Setting a constant current output.

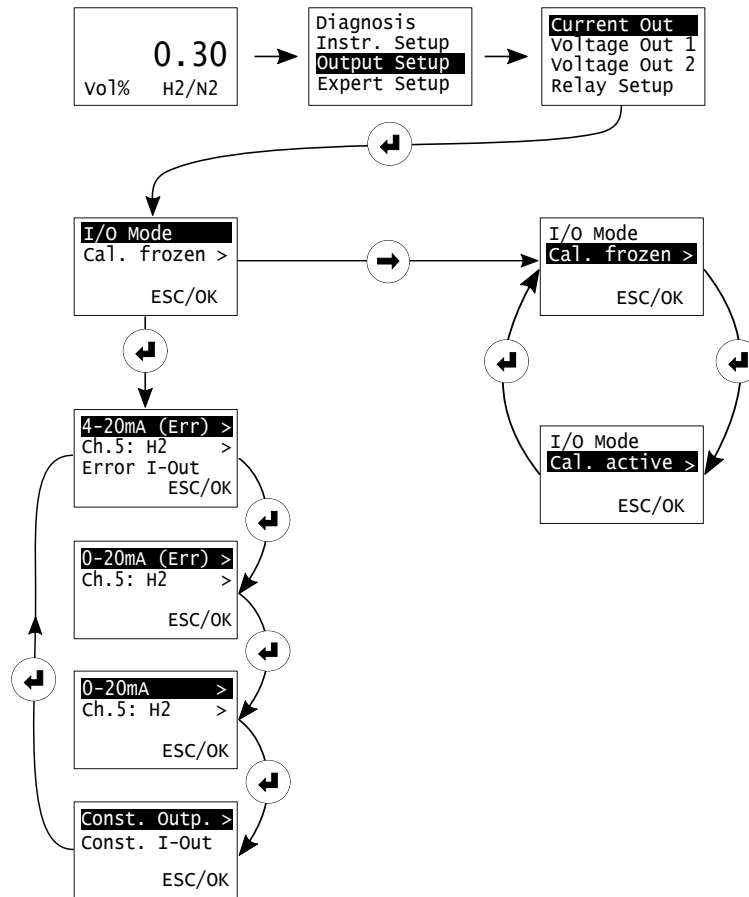

Figure 6.9: Current output setup

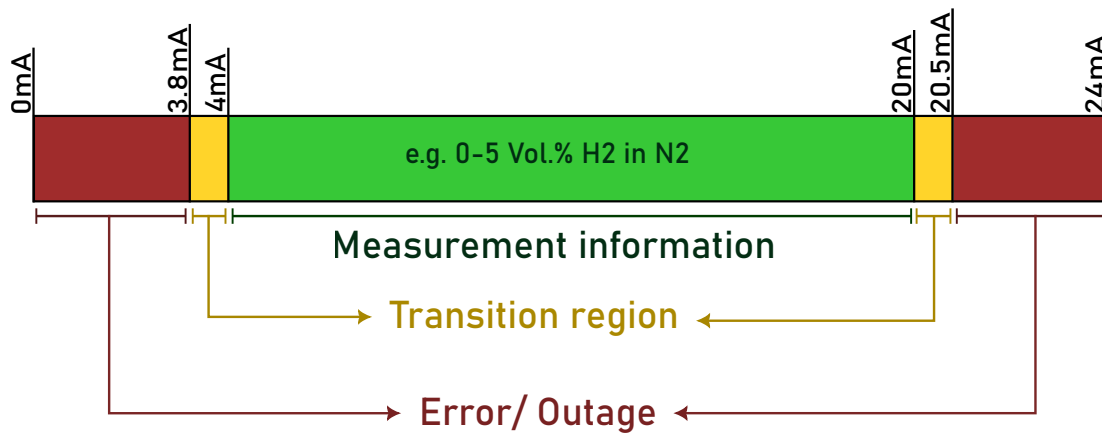
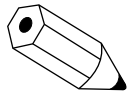

Figure 6.10: The mode **4-20mA (Err)** corresponds to the NAMUR recommendation NE43.



**Example:**

FTC320 with range: **0-5 Vol.% H2 in N2**  
 Current output mode: **4-20 mA (Err)** (default)

As long as the measurement value is in the range 0-5 Vol.% the H<sub>2</sub>-concentration can be calculated from the current signal *I* by:

$$H_2 = \frac{I - 4mA}{20mA - 4mA} * (5Vol.\% - 0Vol.\%) + 0Vol.\%$$

H <sub>2</sub> in N <sub>2</sub>	Current signal
0.00Vol.%	4 mA
3.00Vol.%	13.6 mA
5.15Vol.%	20.48 mA
5.20Vol.%	20.5 mA
6.00Vol.%	20.5 mA

Table 6.3: Current signals at different gas concentrations in the mode 4-20 mA (Err)

In the transition region - here up to approximately 5.15 Vol.% - the current loop is still providing a valid measurement information. If the H<sub>2</sub> concentration rises above this, the signal will be held at 20.5 mA. Note, that similarly to exceeding the measurement range, the concentration indication may also fall below the measurement range, in this example this would mean a negative concentration value. This may happen by signal drift or, applied to the example above, if a gas with lower thermal conductivity than N<sub>2</sub> (e.g. containing CO<sub>2</sub>) is led into the device.

## 6.4.2 Voltage Output Setup

The voltage outputs setting is analogous to the current output's in structure and operation. This section will describe in detail how the voltage output settings can be adjusted as desired.

The FTC320 has 2 voltage outputs that can be mapped to two different gas concentrations. Either or each of them can be mapped to a measuring channel. The typical assignments of the channels, which are the voltage signal's possible sources, are listed in Table 6.1 above.

The voltage output settings are described below:

1. From the **Output Setup** menu, select **Voltage Out 1** (or **Voltage Out 2**).
2. A new menu opens with 2 options: **I/O Mode** and **Cal. frozen**.

In the latter you can toggle between the options **Cal. frozen** and **Cal. active** to determine the behavior of the voltage output during calibration:

- **Cal. frozen:** freezes the current output to the last value before calibration in order to avoid unnecessary jumps during e.g. the logging of the current values.
- **Cal. active:** shows the actual current output during calibration.

The voltage output settings are, however, found under **I/O Mode**. Clicking <ENTER> after highlighting it opens the menu where the different voltage output modes can be adjusted.

3. Press <ENTER> on the first display line successively until you reach the desired voltage output mode (see Table 6.4).
4. **Changing the signal's source:** from the second display line where usually **Ch. 5** is shown, the source of the voltage signal can be changed. To change the channel, click <ENTER> key multiple times to toggle through the channels until you reach the desired channel. (see Table 6.1 for the typical assignment of the channels). The gas measured by thermal conductivity is routed to channel 5 (displayed as e.g. **Ch5. H2**).
5. **Changing the value of the constant output:** in case you chose the **Const. Outp.** mode, you can manually change the value of the constant voltage output by moving the cursor to the second display line **Const. U-Out**, clicking <ENTER>, and entering the desired value followed by clicking **OK** (see Figure 6.11).

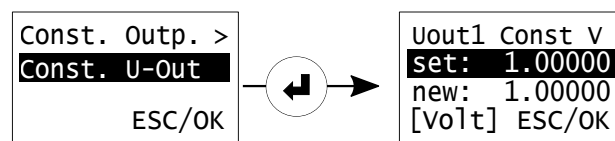

Figure 6.11: Setting a constant voltage output.

These settings can be set for each voltage output, **Voltage Out 1** or **Voltage Out 2**, separately.

Output Mode	Voltage Range	Error Indication
0-10V	output voltage range: 0-10 V, minimum: 0 V, maximum: 10.5 V	no error indication
0-5V	output voltage range: 0-5 V, Minimum: 0 V, maximum: 5 V	no error indication
2-10 (Err)	output voltage range: 2-10 V, minimum: 1.9 V, maximum: 10.25 V	error value: 1.5 V
Const. Outp	The output voltage is constant, its value can be configured to any value between 0-10 V	no error indication

Table 6.4: Available modes of the voltage outputs

The minimum and maximum values given in the table indicate the limit values of the transition region. The analog output is held at these values when the measured variable falls below or rises above the limit value.

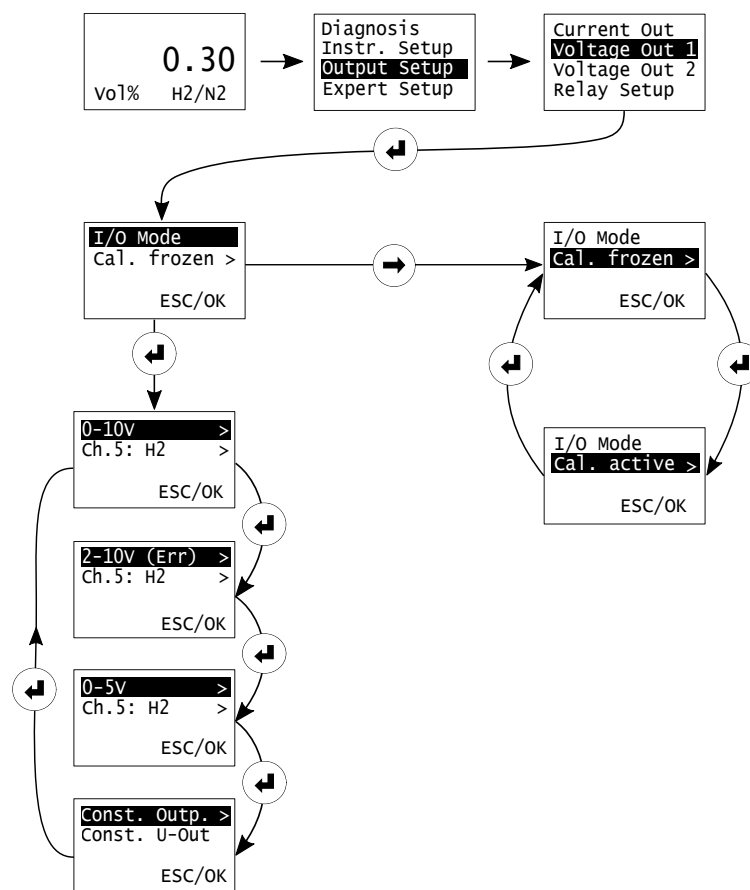

Figure 6.12: Voltage output setup

### 6.4.3 Relay Setup

The FTC320 has three relays, which can be flexibly set up to signal internal device states. The three relays have identical electrical specifications (see Section 9.2) and do not differ otherwise in their functionality.

The relays can be switched by the following signal sources:

- **Limits:** Up to two limits can be defined for each measuring channel, see Section 7.3. The two limits, designated as "Limit 1" and "Limit 2", followed by the channel number (typically "Ch. 5", short for channel 5, the thermal conductivity channel), can be flexibly assigned to a single relay or to different relays.
- **Errors:** Device faults identified by the FTC320, such as sensor element failure or a problem with temperature control. Individual faults can be excluded from signaling.
- **Maintenance Request:** As of August 2023, this display is used exclusively to signal unusual deviations during the calibration of a measuring channel, for example if the signal has fluctuated unusually strongly during sampling.

If you want to use the relays to signal limits, you must set up the limits before configuring the relays. Only after activating a limit as either "Low-High" or "High-Low" will it be visible in the relay settings. See Section 7.3 for setting up the limits.

#### Note on Multi Gas Mode (MGM)

The Multi Gas Mode allows to measure changing gas pairs by thermal conductivity with a single FTC320 (see Section 7.1). When the active gas pair is changed (for example, from H<sub>2</sub> in N<sub>2</sub> to He in CO<sub>2</sub>), a gas pair-specific linearization, calibration, and range setting is loaded into measurement channel 5 (thermal conductivity measurement) of the instrument.

Each gas pair also has separate limits / thresholds, which are also changed when switching. This means that "Limit 1 (Ch.5)" and "Limit 2 (Ch.5)" can have different settings depending on the currently selected gas pair - so "Limit 1 (Ch.5)" and "Limit 2 (Ch.5)" can have different switching behaviors (Low-High, High-Low, or even Off) and different threshold or hysteresis values for each gas pair.

However, the assignment of the limits to the relays and the other settings of the relays (failsafe/not failsafe and cal. active/cal frozen) remain the same when the gas pair is changed. By clever setting of the limits and relays, many conceivable circuit concepts can still be realized despite this limitation. Feel free to contact Messkonzept if you need further information or support with the setup.



## 6.4.3.a Relay Trigger

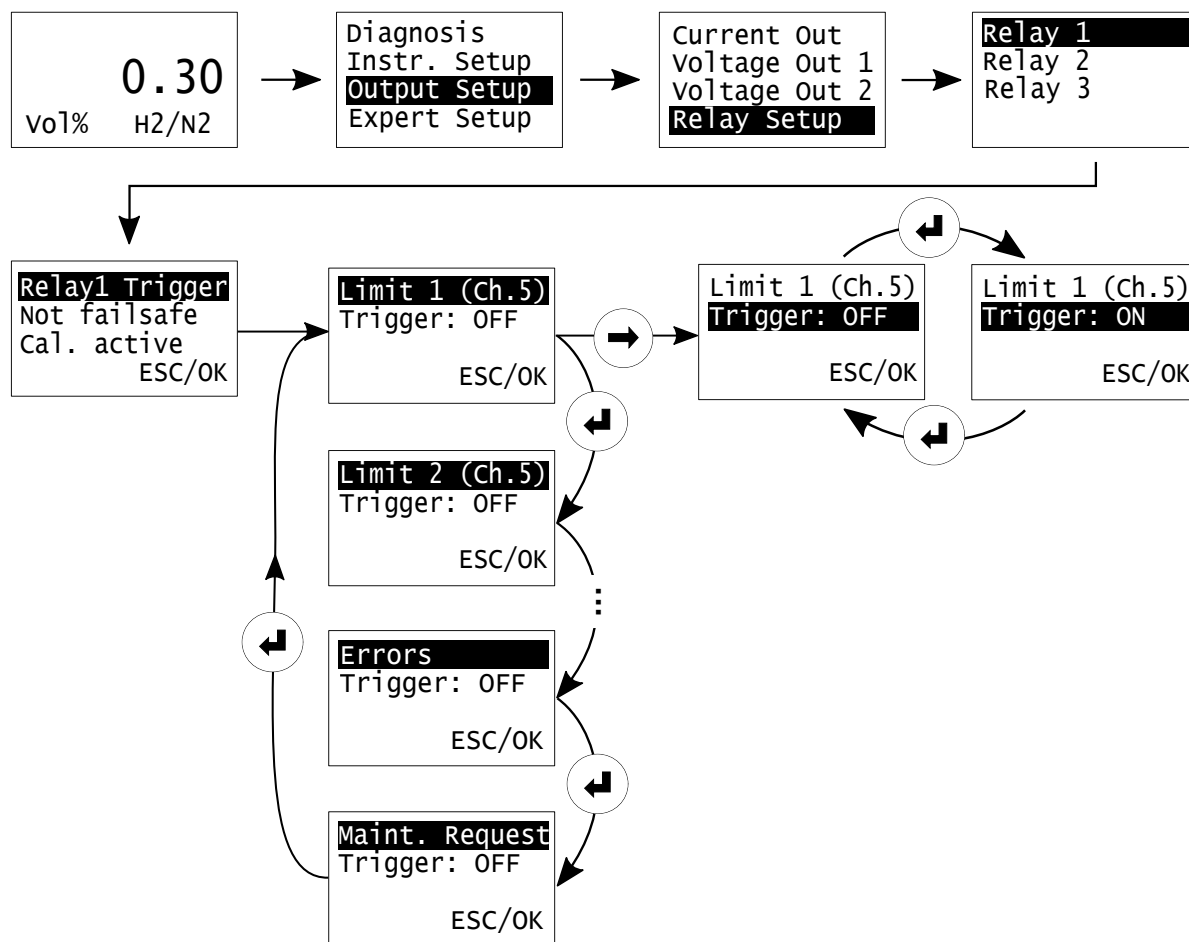

Figure 6.13: Relay Setup: Configuration of trigger criteria for Relay 1.

The trigger / switching criteria of the three relays can be set as described below:

1. Starting from the main menu (<UP> key), you can find the relay settings under: **Output Setup -> Relay Setup**. Here one of the three relays can be selected.
2. Select the menu item **RelayX Trigger** (X: Index of the relay: 1, 2 or 3) with the <ENTER> key. A view of selectable switching criteria opens. The first line of the screen shows the name of the switching criterion, for example "Limit 1 (Ch.5)" for Limit 1 of the fifth measurement channel - Note: Channel 5 is the gas concentration measured by thermal conductivity. Pressing the <ENTER> key while the first screen line is highlighted will display the next switching criterion. Only active limits (configured as "Low-High" or "High-Low") can be selected as switching criteria. See Section 7.3 for information of the limit setup.
3. The second screen line **Trigger:...** indicates whether the switching condition is linked to the relay. Select the line with the <RIGHT> key and press <ENTER> to toggle the state between "ON" and "OFF". Multiple triggers can be selected for one relay.
4. Confirm the selection with "OK" or discard the made changes with "ESC".

### 6.4.3.b Relay failsafe / not failsafe

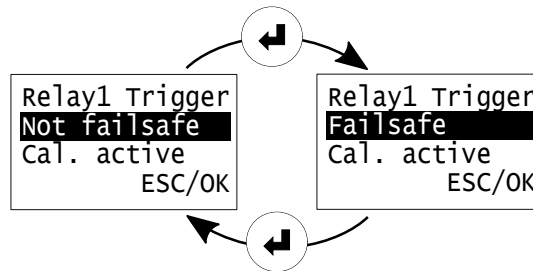

Figure 6.14: Failsafe: Switching contact of the relay is normally closed, it opens when the switching criterion occurs.

Each relay can be configured as failsafe or not failsafe. If the relay is set as failsafe, it is energized and closed in the idle state. A switching condition (depending on the setting: limit value, device error, maintenance request) is signaled by opening the working contacts. This has the advantage that both an interruption of the supply voltage of the FTC320, as well as line interruption at the working contacts can be perceived as error cases.

If the setting of the relay is "Not failsafe", current does not flow through the relay in the idle state, the switching contacts of the relay are then open. A switching criterion / alarm is then signaled by the relay coil receiving voltage in the event of a trip. An interruption in the power supply to the encoder or a cable break to the normally open contacts cannot be signaled in this way.

To change the setting, select the second line of relay settings with the <RIGHT> key and toggle between "Failsafe" or "Not failsafe" by pressing the <ENTER> key. To make a changed setting effective, the relay settings must be confirmed with "OK".

### 6.4.3.c Relay active / not active during calibration

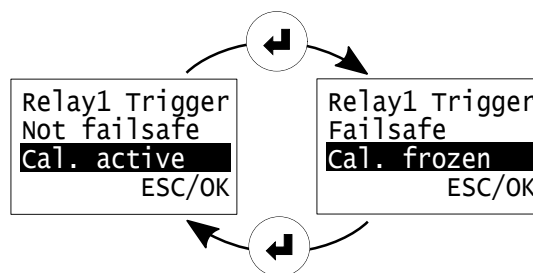
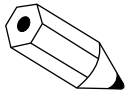

Figure 6.15: Cal. frozen: The state of the relay will not change during calibration.

Each relay can be configured as "Calibration active" or "Calibration frozen". With the "Cal. frozen" setting, the relay does not respond to a change in the measured value during calibration: For the duration of the calibration procedure, the relay will remain in the state it was in before calibration began. This function prevents alarms from being triggered by the calibration gases.

"Cal. active" means that the relay will behave according to its settings even during calibration. To change between "Cal. frozen" and "Cal. active", highlight the third line by pressing the <RIGHT> key

and press <ENTER>. To make a changed setting effective, the relay settings must be confirmed with "OK".



The setting "Cal. frozen" only has an effect if calibration is triggered via the display interface of the FTC320. When calibrating via the service tool (SetApp) or otherwise via the digital interface (RS232/RS485), the setting has no effect. In this case, the inlet of the calibration gas does not represent an operating state that is separated from the regular operation - the relays and analog outputs therefore react to the incoming gas.

## 6.5 Expert Setup

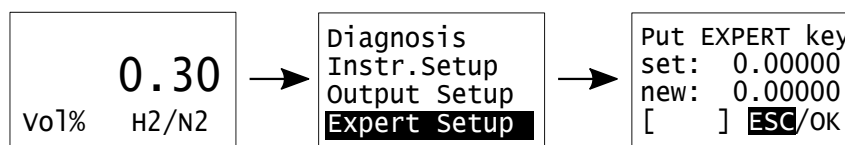

Figure 6.16: Expert Setup menu

The Expert Setup provides a couple of functionalities that should only be used by an advanced user or expert:

- set parameters
- change the "Operator Code" and the "Expert Code"
- reset to factory settings
- Setting error messages to be ignored



The settings explained here are for advanced users or experts and should not be entered by normal operators. It is in the responsibility of experts to set the parameters properly. The default expert code is "222.000".

### 6.5.1 Parameter

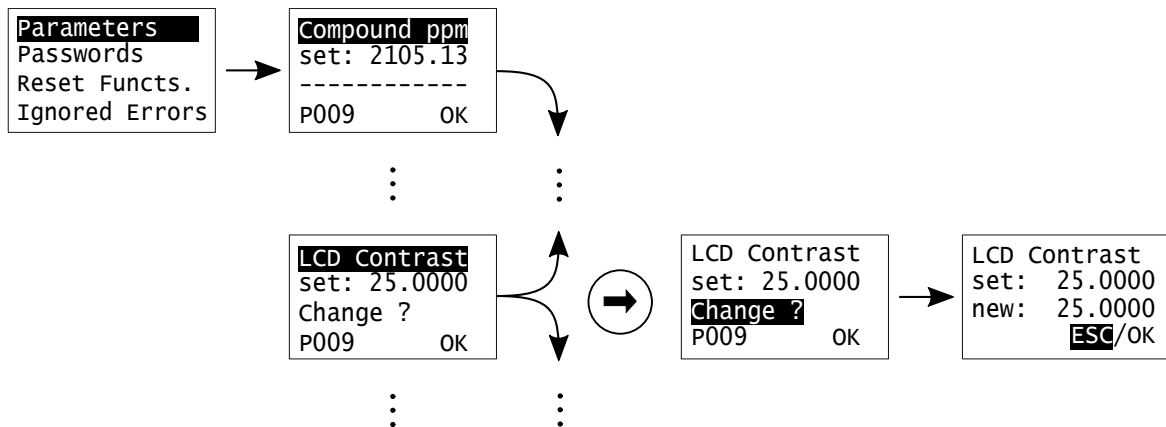

Figure 6.17: Parameter change in expert mode

The configuration of the FTC320 is represented by an internal list of parameters. These parameters govern all settings and functions of the device. In the expert-menu's parameter list press <ENTER> to scroll forward through the list and backwards by pressing <UP>. Some parameters cannot be changed (e.g. sensor information such as "Compound ppm", see Figure above) others can be changed (e.g. "LED Contrast", see Figure above). All changeable parameters are indicated by "Change?" in the third line of the display. Selecting and clicking "Change?" opens a submenu in which a parameter's value can be modified.



Setting certain parameters to improper values can cause faulty measurement results, malfunctions, or even permanent physical destruction of the device!

### 6.5.2 Passwords

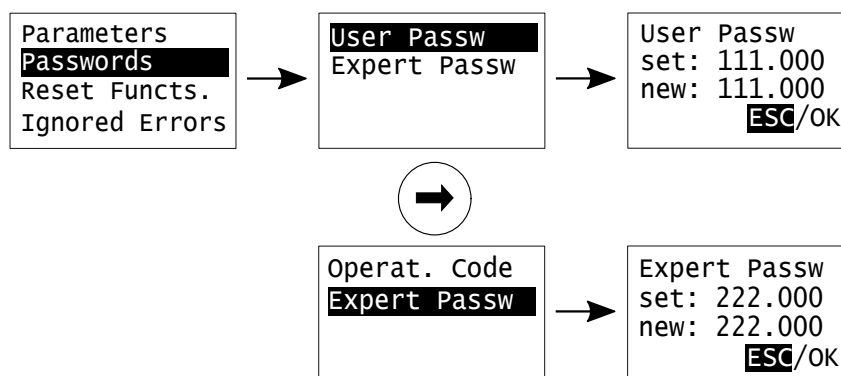

Figure 6.18: Passwords menu

In this menu the passcodes for the "Operator Mode" (User Password) and the "Expert Mode" (Expert Password) can be changed.

### 6.5.3 Reset Functions

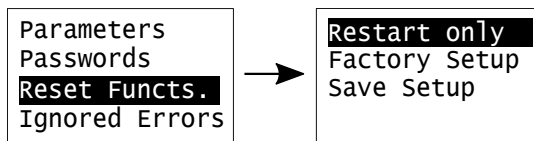
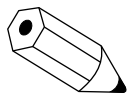

Figure 6.19: Reset Functions menu.

This menu provides the possibility to restart the device or to restore the factory setting of the device:

- “Restart only“: Restart of the device
- “Factory Setup“: Resets all parameters to the factory set values. **Careful! This is irreversible!**
- “Save Setup“: Overwrite the Factory Setup. **Careful! This is irreversible!**



If a reset to Factory Settings is performed, a new calibration might be necessary. Please verify the device functionality with test gases before resuming regular operation of the device.



The “Save Setup” function overwrites the factory settings and cannot be reversed. This function should only be used in special cases and in consultation with Messkonzept service.

## Chapter 7

# Measurand related settings

For each measured variable, usually given by a gas concentration, measurand-related settings can be changed. The settings related to the measured parameter can be accessed from the working screen by selecting the measured parameter with the <RIGHT> key and confirming with the <ENTER> key (see Figure 7.1). The calibration and the alarm setup of the measured parameter can be called up in the parameter-related menu.

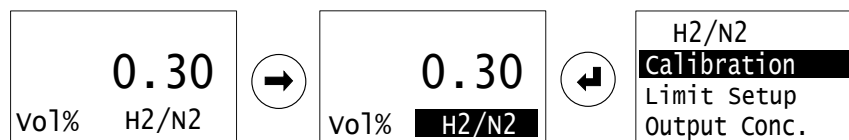
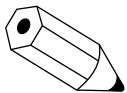

Figure 7.1: Accessing the settings related to the measured parameter.

To select the following menu item in the measurand related menu, press the <RIGHT> button. Pressing the <ENTER> button selects the highlighted menu item with a black background and opens the sub-menu.



All inputs of numbers within the menu structure work according to the following principle: With <RIGHT> the respective digit of the number can be selected and with the <UP> key the digit can be changed. Select "OK" with <RIGHT> and confirm with <ENTER> to save the changes and return to the previous menu. Selecting "ESC" interrupts the input and discards changed values.

### 7.1 Gas pair selection (only with Multi Gas Mode)

In a device with multi-gas mode, the gas pair measured using thermal conductivity can be changed. This allows the use of a FTC320 in changing applications - for example to monitor the purity of different gases one after the other. The desired gas pairs, which are available in multi-gas mode, must be specified when ordering the device; they are entered and calibrated at the factory.

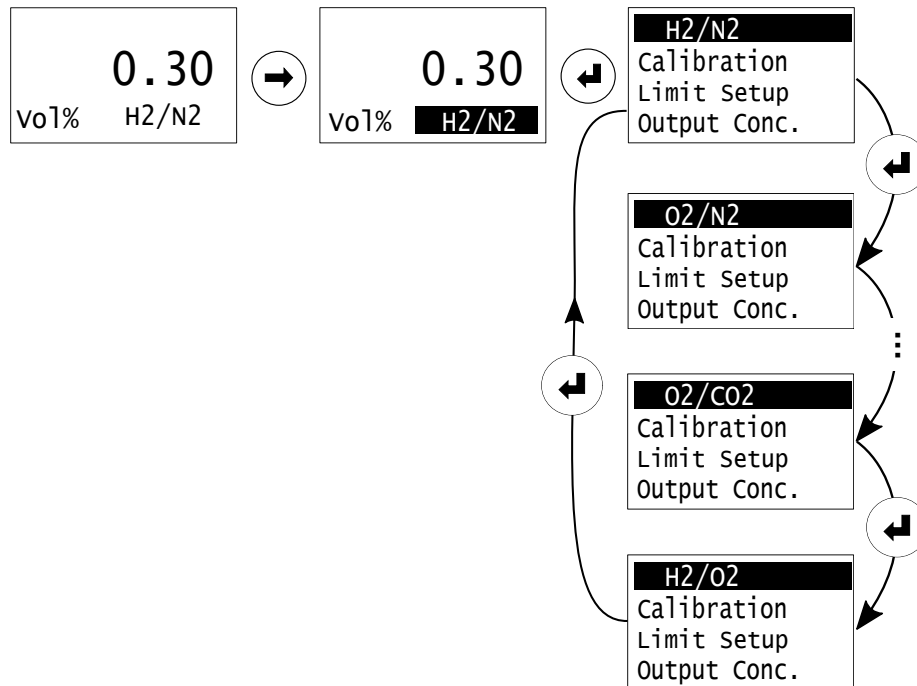

Figure 7.2: Multi Gas Mode: Changing the active gas pair

The currently active gas pair is displayed in the first line of the measurement-related settings. Select the first line (if necessary by pressing the <RIGHT> button several times) and press <ENTER> to switch to the next gas pair. Changing the gas pair takes 1-2 seconds - during this time, the parameter set of the selected gas pair is loaded into the active memory area of the device. Settings of the previously selected gas pair are retained.

When the gas pair is changed, the specific linearization curve of the gas pair now to be measured is activated and all measured variable-related settings are loaded for the specific gas pair:

- Calibration, as well as the settings for calibration (reference gas concentrations: "Offset Gas", "Gain Gas", see Sections 7.2.1 and 7.2.2)
- Configuration of the limits / limit values "Limit 1 (Ch.5)" and "Limit 2 (Ch.5)", see Section 7.3
- Measuring range and analog output range ("C-> Min. outp." and "C-> Max. outp.", see Section 7.4)

Please note that the settings for analog outputs and relays (part of the "General device configuration", see Chapter 6) do not change when the active gas pair is changed. They may need to be adjusted manually when changing the gas pair.

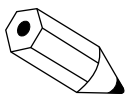

If it is not possible to select the first screen line, Multi Gas Mode is not available for your device or you may have selected an external measured variable for which Multi Gas Mode is not available on a device with several measured variables (e.g. with an external oxygen sensor).

## 7.2 Calibration

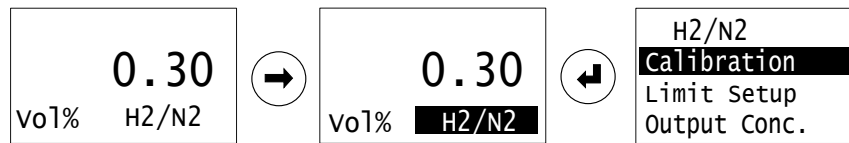
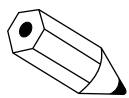

Figure 7.3: The calibration functions can be found amongst the measurement related settings

In this section the calibration via the display interface of the FTC320 is explained. **Before beginning with the actual calibration procedure, please review section 2.2, which explains how calibration affects the measurement value and how the calibration should be planned.**



In the majority of cases, gain calibration is not needed. The thermal conductivity measurement generally only has a very small drift, which is largely constant over the entire measuring range and can therefore be compensated for very well by offset calibration. Improper gain calibration can impair the accuracy of the measurement.

### 7.2.1 Set Offset Gas Concentration

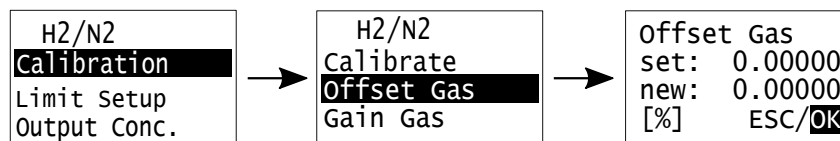

Figure 7.4: offset gas setup menu

Before performing a calibration, the concentrations of the used test gases have to be set. In the sub-menu “Offset Gas“ the used concentration of the offset gas has to be entered. Select the sub-menu “Offset Gas“ by pressing the <RIGHT> key and press <ENTER> to open the menu for the numerical entry. Enter the offset calibration gas concentration by changing each digit to the desired value. The position of the cursor in the number is moved by the <RIGHT> key, the value of the digit (0-9 or . for the decimal separator) at the current position of the cursor is changed with the <UP> key. When the correct value is set, move the cursor to “OK“ and confirm with <ENTER>.

### 7.2.2 Set Gain Gas Concentration

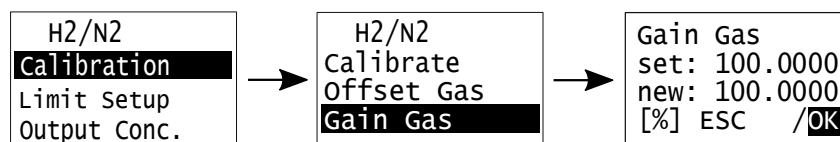

Figure 7.5: gain gas setup menu

Prior to a two-point calibration, the gain gas concentration has to be set in the sub-menu “Gain Gas“. This menu is operated analogously to the “Offset Gas“ menu described in Section 7.2.1.



### 7.2.3 Offset Calibration

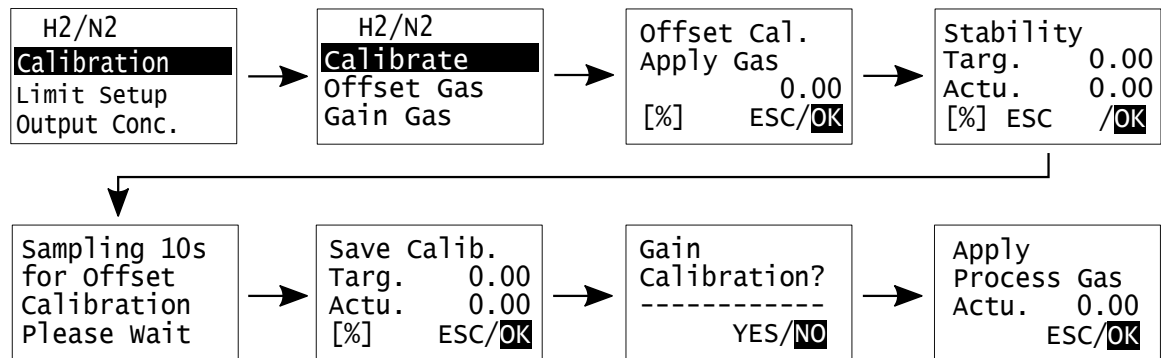
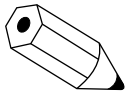

Figure 7.6: menu path if only offset is calibrated.

Before calibration, the test gas concentration must first be set, please note Section 7.2.1 (and if necessary Section 7.2.2 for a two-point calibration).

When you have selected the menu item **Calibrate**, you will be prompted to apply the offset test gas (**Apply Gas**). The third line of the screen displays the preset target concentration (offset gas), which has been set beforehand. The unit used is shown in the bottom left-hand corner. If the test gas used matches the specifications in the menu, the test gas can be introduced - ideally under conditions that are similar to the process conditions in measuring operation (same flow, pressure, humidity<sup>1</sup>). Confirming with **OK** leads to the menu item **Stability**. The target concentration (**Targ.**) and the currently measured gas concentration (**Actu.**) are displayed in the menu item **Stability**. After a sufficiently long run-in time, which depends on the set gas flow and the length of the supply line between the test gas cylinder and the measuring device, the currently displayed concentration should reach a stable value.



Please note that any large change in flow, pressure or concentration, for example when opening a valve for the test gas flow, will cause a small disturbance to the thermostated measurement in the FTC320. This is particularly the case if you accidentally had a very high gas flow, even for a short time. It may take several minutes for the temperatures in the FTC320 to reach equilibrium again and for the measurement indication to provide a stable and reproducible value in the ppm range.

To start the calibration sampling, select "OK" and press <ENTER>. The sampling phase of 10s is started. Based on the average measured concentration, the new offset is determined such that the currently measured (and calibrated) value accords with the given test gas concentration within the specifications of the device. Repeat the calibration in case the measured concentration after calibration is not in agreement with the test gas concentration. By selecting "ESC" and pressing <ENTER>, the offset calibration is repeated. With "OK" the calibration is confirmed as correct and the new offset value is saved.

<sup>1</sup>slightly different rules apply for devices with cross compensation against actively measured disturbances, e.g. using a humidity sensor. Here it is important to calibrate in the operating point, where the compensation is not active - typically this is in the complete absence of the disturbance, for example in dry gas. Please contact Messkonzept regarding the best practices for your device-specific compensation routine.

The following menu offers the option to proceed with the gain calibration. Choosing “YES“ leads to the gain calibration menu described below.

If only a single-point calibration is desired, **NO** is selected, whereupon the **Apply Process Gas** menu opens. You have time to restore normal measurement operation while alarm relays (depending on the setting) remain inactive.

### 7.2.4 Gain Calibration

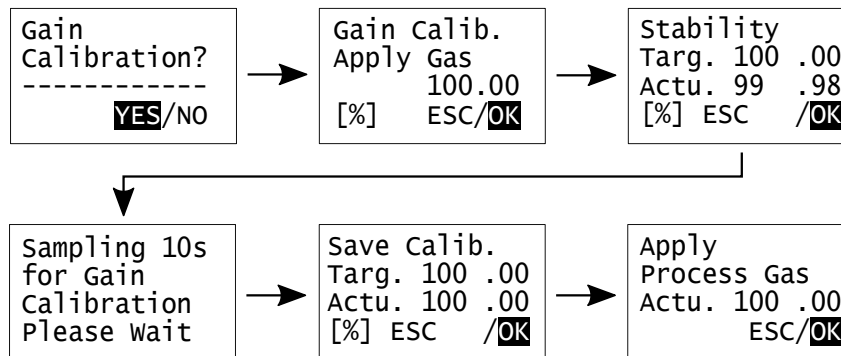

Figure 7.7: menu path of the gain calibration

The menu navigation only allows gain calibration after offset calibration has been carried out, as meaningful gain calibration is only possible in this order. The steps for gain calibration are similar to those for offset calibration, except that gain test gas must of course be used here. Perform the gain calibration by selecting **YES** with <ENTER>. The gain calibration can be canceled with **ESC** from any submenu to return to the **Gain Calibration** menu. If the user selects **Gain Calibration** in the **NO** menu, he ends the gain calibration and is prompted to introduce the measuring gas. The slope of the calibration line (gain) then remains unchanged at the value of the last gain calibration confirmed with **OK**.

### 7.3 Limit Setup

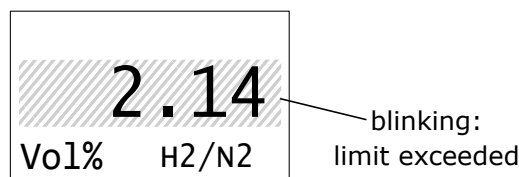

Figure 7.8: Indication of an exceeded limit / process alarm on the FTC320.

Up to two limit values (limits) can be set for each measuring channel. If the monitored measured variable exceeds the limit value, this is indicated by the measured variable flashing on the display, see Figure 7.8. Limit values can be signaled flexibly via the three available relays, see Section 6.4.3. Please note that the relays can only be linked to the limit values if the limit values have been set beforehand. The following Section 7.3.1 explains how to set the limit values, Section 7.3.2 shows some examples of how the limit values can be used in different applications.

### 7.3.1 Configuration of a Limit

The process limits are configured via the measurement related settings: Starting from the main view, the measured variable can be selected with the <RIGHT> button (see marking of "H2/N2" at the top left in Figure 7.9). Confirm with <ENTER> to open the menu for the measured variable. In this menu, use the <RIGHT> button to select the "Limit Setup" line and confirm with <ENTER>.

Each measuring channel has two limit values that can be activated and configured independently of each other. After selecting the limit value to be configured with the <ENTER> button, the current limit value setting is displayed.

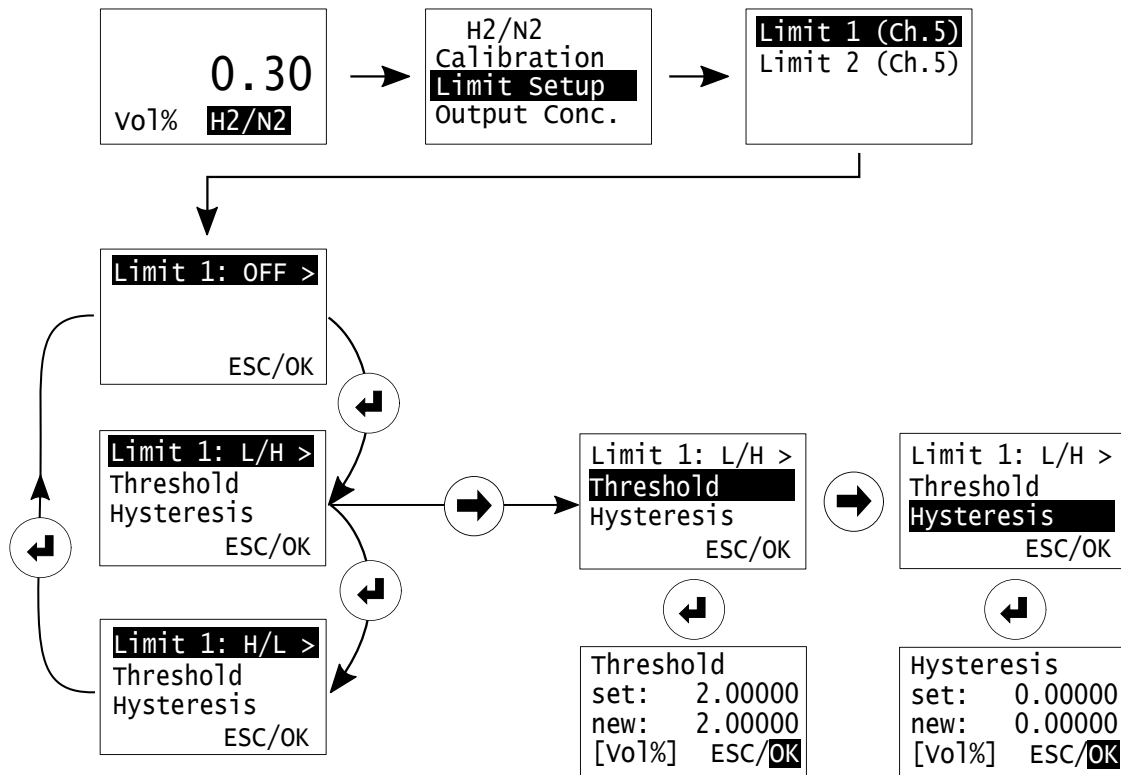

Figure 7.9: Configuration of a Limit.

Figure 7.9 shows the menu path as an example for Limit 1 of channel 5 (gas concentration measured by thermal conductivity).

In the limit setup, the first line of the screen shows the currently configured mode of the limit value. One of the following modes can be selected

- **OFF**: The limit is inactive.
- **L/H**: Signaling when the switching point (threshold) is exceeded from bottom to top.
- **H/L**: Signaling when the switching point (threshold) is undershot from top to bottom.

To change the mode, press the <ENTER> button while the first line of the screen is highlighted. To set the switching point of the threshold or the hysteresis, select the second or third screen line with the <RIGHT> button and press <ENTER>. The value after "set:" indicates the current setting, the <RIGHT> button can be used to select the digits of the new value to be set "new:" and manipulated with the <UP> button. The setting can be confirmed with "OK" and discarded with "ESC".

### 7.3.1.a Hysteresis

In order to avoid frequently changing switch-on and switch-off processes of relays at an alarm limit value, a hysteresis value can be set. The setting is made in the measuring unit used (e.g. Vol% or ppm). The hysteresis is implemented as follows in FTC320:

- **L/H**: Limit value switches on when the threshold is exceeded, it is switched off when the threshold - hysteresis is undershot, see Figure 7.10.
- **H/L**: Limit value switches on when threshold is undershot, it is switched off when threshold + hysteresis is exceeded, see Figure 7.11.

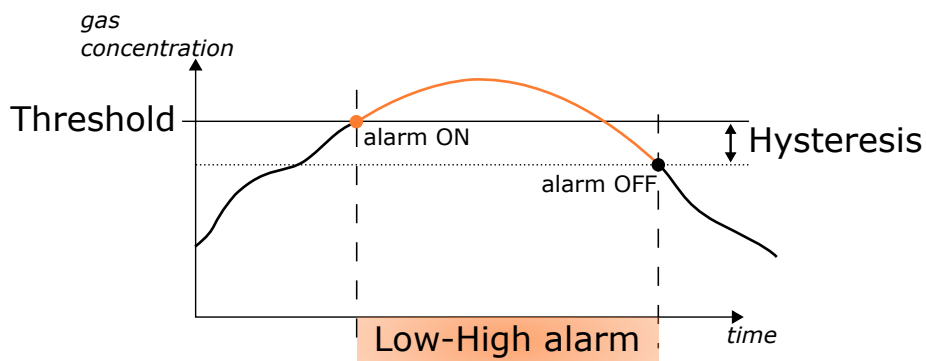

Figure 7.10: Hysteresis behavior when setting the limit type Low-High.

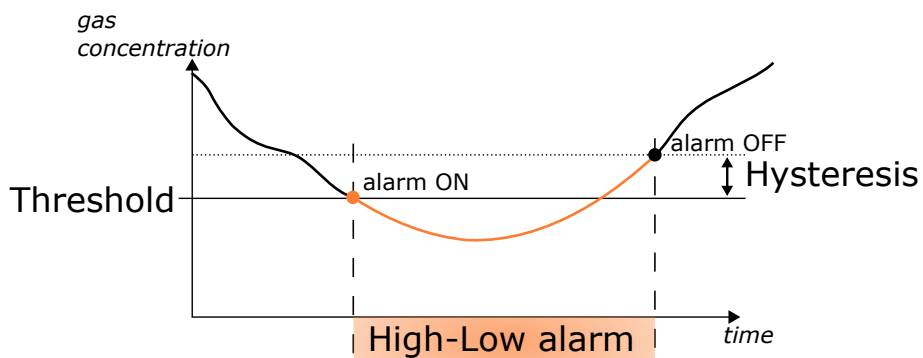

Figure 7.11: Hysteresis behavior when setting the limit type High-Low.

### 7.3.2 Examples

#### Example 1 - Monitoring a lower explosion limit

Limit values can be used, for example, to monitor an explosion limit. For hydrogen in oxygen under atmospheric pressure, the lower explosion limit (LEL for short) is approx. 4 Vol.% - a reasonable alarm threshold may be at 50 % LEL, i.e. 2 Vol.%, see figure 7.12. If the limit value is linked to a relay, a safety shutdown can be implemented. Section 6.4.3 explains how the relays can be switched by limit values.

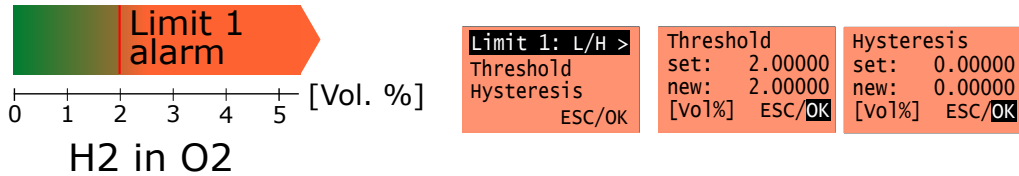

Figure 7.12: Limit alarm at 50 % LEL.

#### Example 2 - Two-stage monitoring of a lower explosion limit

More complex circuits can be realized by using both limit values of a measured variable. For example, a two-stage alarm is possible, see Figure 7.13.

Limit 1 as a pre-warning level at 1 Vol.% (~25 % LEL) could, for example, be used to switch a warning light via one of the relays, Limit 2 at ~50 % LEL could be coupled to a safety shutdown.

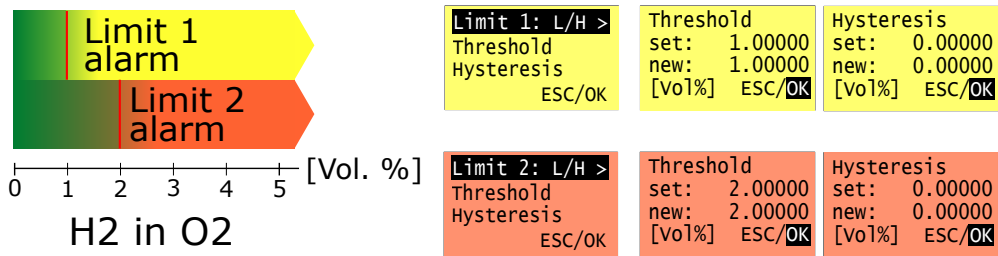

Figure 7.13: Two stage limit alarm: Limits at 25 % LEL and 50 % LEL.

#### Example 3 - Process window with hysteresis

If one limit value is configured as high-low and the other as low-high, a process window can be monitored, see figure 7.14. If this is used to switch a feedback process, it may be useful to set a hysteresis.

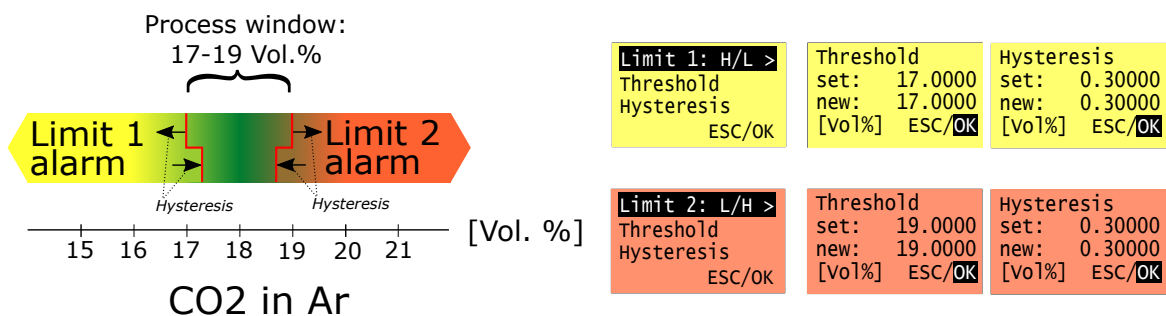

Figure 7.14: Monitoring of a process window: Gas mixer control for shielding gases for welding.

## 7.4 Mapping of Analog Output

By default, the (analog) output range of a measured variable is preset to the measuring range (see nameplate). If required, this output range can also be configured to other start and end values.

Under **Output Conc.**, the minimum and maximum output concentrations can be set as follows: (see Figure 7.15)

- **Setting the Minimum Output:** from the menu **Output Conc.** choose **C-> Min. Outp.**, type in the new value, then confirm by clicking **OK**.
- **Setting the Maximum Output:** from the menu **Output Conc.** choose **C-> Max. Outp.**, type in the new value, then confirm by clicking **OK**.

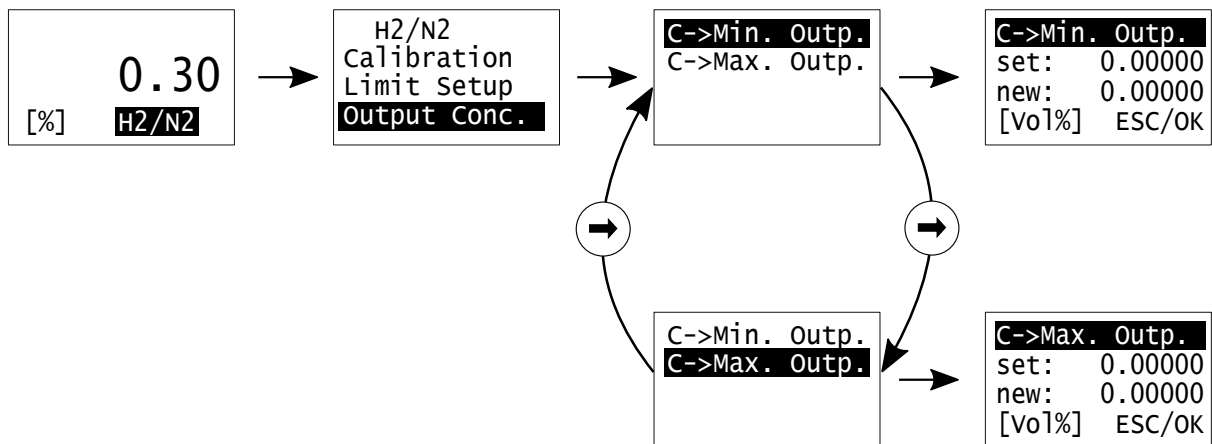

Figure 7.15: Adjusting the output concentration.

## Chapter 8

# Appendix: System Errors

In this appendix possible error messages on the FTC320 (see Section 6.2.2) are listed.

In case of an error please check for the description of the error and the actions recommended to remove potential causes. In case this does not lead to a solution, please contact Messkonzept and describe the circumstances that led to this error. Some issues can be resolved through remote maintenance.

If the error persists you might be requested to send the FTC320 back to Messkonzept. Please pay attention to these points when sending the device:

- Close gas ports to keep gas duct clean. Preferably use black rubber caps that came with delivery.
- Put the device in a suitable shockproof packing material. Preferably use the foam box that came with delivery.
- Please attach a brief note with a description of the problem or refer to prior mail correspondence on this subject with Messkonzept.



Never open the housing of the FTC320. Warranty is void if the housing was opened, refrain from attempts of repairing the device yourself! Messkonzept may charge more for the repair if the housing was opened. It is more work to check if an attempted repair by the user lead to further damages.

Displayed label	Cause	Default range	Corrective Measure
EEPROM ERROR	Error reading or writing data to or from internal FLASH-EEPROM	-	Repeat procedure. If the error persists, send the device to Messkonzept with description of error.
CAL GAIN ER	Calibration gain exceeding max. allowed range	0.5-1.5	Check if the used test gas concentration gives the set concentration. Repeat procedure. If the error persists, send the device to Messkonzept with description of error.
CAL OFFS ER	Calibration offset exceeding max. allowed range	100 mV	See CAL GAIN ER
CAL DEV ER	Calibration deviation exceeding max. allowed range	50000 ppm	See CAL GAIN ER.
CAL VAR ER	Calibration variation exceeding max. allowed range	1000ppm	Repeat procedure. Check if the measurement is stable before data sampling. Are there sudden fluctuations in relevant process parameters, for example pressure pulses caused by a pump? Has the calibration gas flooded the device properly? Please verify your calibration setup and repeat the calibration. If the error persists, send the device to Messkonzept with description of error.
BT MIN(WARMUP)	Block temperature not yet reached (warm-up)	SetTemp-2K	This error message should only appear within the first max. 20 minutes of device operation. The device is still warming up, will therefore not measure according to specification. Please wait for a couple of minutes and see if the temperature is reached.



Displayed label	Cause	Default range	Corrective Measure
BT MIN ER	Block temperature below specified range	SetTemp-2K	This error may occur shortly after a very big change in gas concentration or in gas flow. Please wait for a couple of minutes and see if the error persists. One reason for the error might be operation of the device outside the specified ambient temperature or gas temperature range. Consider the device specifications. If the error persists, send the device to Messkonzept with description of error.
BT MAX ER	Block temperature above specified range	SetTemp+2K	<i>See BT MIN ER.</i>
TC SENS ERROR	TC-signal outside allowable range	1 - 7 V	Send the device to Messkonzept with description of error.
IR SENS ERROR	IR-signal outside allowable range	50-3300 mV	Send the device to Messkonzept with description of error.
O2 SENS ERROR	No connection to oxygen sensor or sensor output outside range	0-32768	Turn off the device, only then check the connection to the external oxygen sensor. If the error persists, send the device to Messkonzept with description of error.
HUMID SENS ERR	No connection to humidity sensor or sensor output outside range	0-100 % rh.	Send the device to Messkonzept with description of error.
PRESS SENS ERR	No connection to pressure sensor or sensor output outside range	10-2000 mbar	Send the device to Messkonzept with description of error.
FLOW SENS ERR	No connection to differential pressure sensor needed for flow measurement		Send the device to Messkonzept with description of error.

Table 8.1: Description of System Errors

## Chapter 9

# Appendix: Specifications

### 9.1 Specification of Thermal Conductivity Measurement

Attribute	Range / Precision
Linearity	< 1 % of range
Warm up time	Approx. 20 min; up to 1 h for small measuring ranges
Flow rate	10 l/h - 150 l/h, 60 l/h - 80 l/h (recommended)
T90-time	< 1 sec at flow rate higher 60 l/h (or dependent on user selected T-90-filter time)
Noise	< 0.5 % of smallest range
Drift at zero point	< 2 % of smallest range per week
Repeatability	< 1 % of range
Error due to change of ambient temperature	< 1 % of smallest range per 10 K temperature change
Error due to change of flow at 80 l/h	< 1 % of smallest range per 10 l/h
Error due to change of pressure (800 hPa < p < 1200 hPa)	< 1 % of smallest range per 10 hPa

Table 9.1: Specification of TC measurement

### 9.1.1 Gas Flow

Article No.	Description	Calibrated at...	Flow at atmospheric pressure
A120B900	without protection	60 l/h	Recommended value: 60 l/h Recommended range: 40 - 80 l/h
A120B901	Protection against corrosion	60 l/h	Permissible range: 10 - 120 l/h
A120B902	Protection against condensate and dust	60 l/h	Recommended value: 60 l/h Recommended range: 40 - 150 l/h
A120B903	Protection against corrosion, condensate and dust	60 l/h	Permissible range: 10 - 300 l/h
A120B907	Low sample gas flow, protected against condensate and dust	10 l/h	Recommended value: 10 l/h Recommended range: 3 - 20 l/h Permissible range: 1 - 60 l/h
A120B907	<i>Low sample gas flow, protected against condensate and dust</i>	30 l/h *	<i>Recommended value: 30 l/h Recommended range: 20 - 40 l/h Permissible range: 1 - 60 l/h</i>
A120B908	Low sample gas flow, protected against corrosion, condensate and dust	10 l/h	Recommended value: 10 l/h Recommended range: 3 - 20 l/h Permissible range: 1 - 60 l/h

Table 9.2: Recommended and permissible gas flow of the different device variants.

\* Example of a custom calibration. Ideally calibration is performed at the same or similar flow rate as during measurement.

## 9.2 Electrical Specifications

Unit / Interface	Feature	Value
Display	128 x 64 dot graphic LCD	
Keypad	3 short-travel keys	
Analog Input 1/2	Voltage range:	0 to 10 V
	Reference potential:	ground
	Input resistance	approx. 50 k $\Omega$
	Resolution	24 bit
Current Loop	Signal Current:	0/4 to 20 mA
	Reference potential:	fully floating, max. $\pm 500$ V to ground
	Burden:	max. 800 $\Omega$
	Resolution:	16 bit
Voltage Output	Voltage range:	0 to 10 V
	Reference potential:	ground
	Load resistance:	min. 50 k $\Omega$
	Resolution:	16 bit
Relay 1/2/3	Maximum Voltage:	30 V
	Switching current:	0.5 A (max.)
	Switching capacity:	10 W (max.)
	Reference potential:	fully floating, max. $\pm 500$ V to ground
Power Supply	Voltage range:	18 - 26 V DC
	Max. current:	1 A
	Typical current draw:	500 mA
	Safeguard:	PELV (Protective Extra Low Voltage)
Digital Interface	Type:	RS-232
	Baud rate:	19.2 kbaud
	Data:	8 bit
	Parity:	None
	Stop:	1
	Flow control	None
	Reference potential:	ground

Table 9.3: Electrical Specifications

### 9.3 Permissible Conditions of the sample to be measured

Pressure (absolute)	Standard version: max. 20 bar abs. with flow measurement: max. 2 bar abs. for flammable gases: max. 3 bar abs. Note the deviations of special models!
Gas temperature	At 60 l/h: - max. 80 °C at 25 °C ambient temperature - max. 50 °C at 50 °C ambient temperature - min. -20 °C for version without glass beads - min. -5 °C for version with glass beads
Dust, aerosols, oil mist, fluids	Avoid at all costs (e.g. via separator/filter), the option "Protection against condensate and dust" can prevent impairment of the measuring capability
corrosive gases	Only with corrosion-tolerant design and after consulting Messkonzept
Humidity	None should exist below dew point temperature in the sample gas path, 60 °C in the measuring devices and, if necessary, heat the connection pipe
Water condensate/drops)	Avoid at all costs, the "Protection against condensate and dust" option can prevent the sensor element from being destroyed by water

Table 9.4: Properties of the sample gas.

Regarding the introduction of flammable and explosive gases in the devices, please note the instructions in section 1.3.

### 9.4 Environmental conditions

Operating temperature:	-20 °C to 50 °C (-4 °F to 122 °F) or if casing filled with glass balls: -5 °C to 50 °C (23 °F to 122 °F)
Storage temperature:	-25 °C to 70 °C (-15 °F to 160 °F) (not-condensing)
Protection class	IP 65 (if cables are plugged and/or all unused jacks are sealed using protective caps)

Table 9.5: Environmental conditions.

## 9.5 Dimensions

Dimensions:	Depth: 85 mm Width: 144 mm Height: 80 mm without connectors
Weight:	max. 1800 g
Mounting:	Wall mounting

Table 9.6: Dimensions.

## Chapter 10

# Appendix: Dimensional Drawing

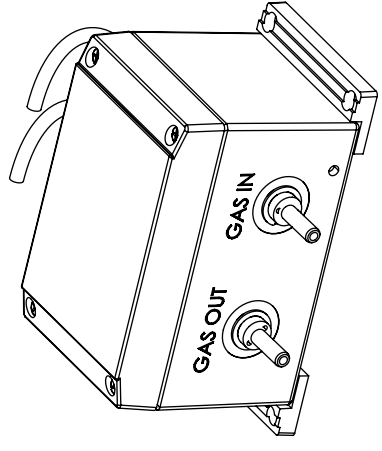

95mm bei fixierten Kabeln /  
 122mm bei losen Kabeln  
 95mm with cables fixed /  
 122mm with cables movable

Steckverbindung / plug-and-socket connection  
 A 7 polig / 7 pins  
 B 5 polig / 5 pins  
 C 8 polig / 8 pins

zulässiger Biegeradius: feste Installation R<sub>min</sub> 53mm  
 bewegliche Kabel R<sub>min</sub> 80  
 tolerable bending radius: fixed installation R<sub>min</sub> 53mm  
 flexibel cable R<sub>min</sub> 80mm

Obfl.:

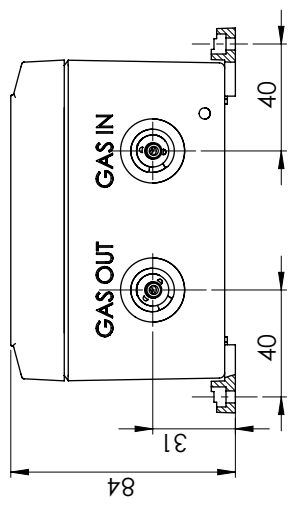

Minimale Freiraum  
 minimal clearance

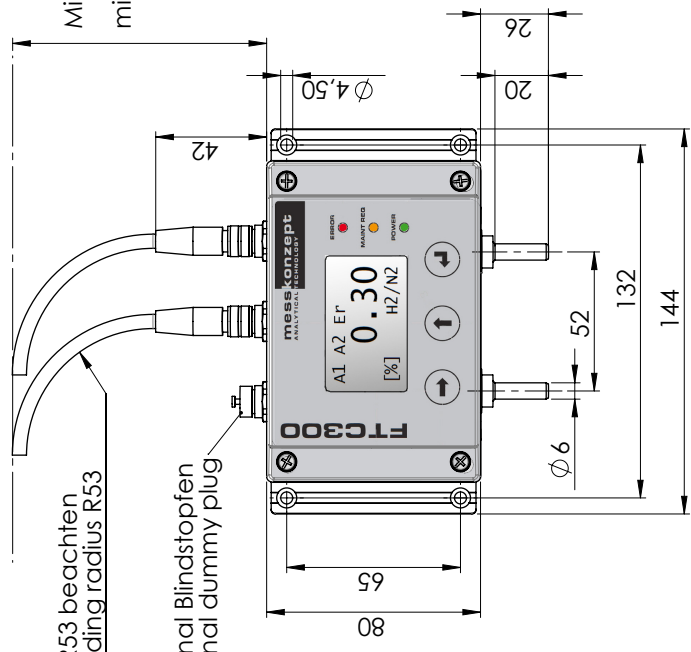

min. Biegeradius R53 beachten  
 consider min. bending radius R53

optional Blindstopfen  
 optional dummy plug

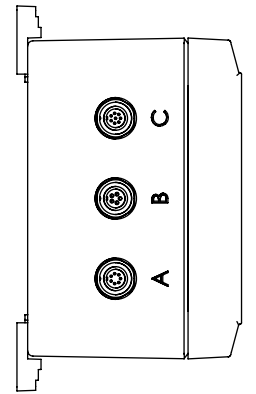

DIN ISO 2768-mK		Maßstab 1:2	
Datum 28.04.2015		Name Ashmore	
21.11.18 VA		28.04.15 VA	
003		002	
01		01	
Zustf.	Änderungsnr.	Datum	Name
FTC 300		Massbild	
A090-X005		Blatt 1	
		1	
		CAD	







## **Messkonzept GmbH**

Analytical Technology

Niedwiesenstr. 33  
60431 Frankfurt  
Germany

Telefon +49 69 53056444

Fax +49 69 53056445

[info@messkonzept.de](mailto:info@messkonzept.de)

[www.messkonzept.de](http://www.messkonzept.de)

Managing Director

Dr. Axel-Ulrich Grunewald

Place of jurisdiction Frankfurt HRB 49940

VAT ID: DE211207233